

SPELLJAMMER[™]



Official Game Accessory

Lost Ships

by Ed Greenwood



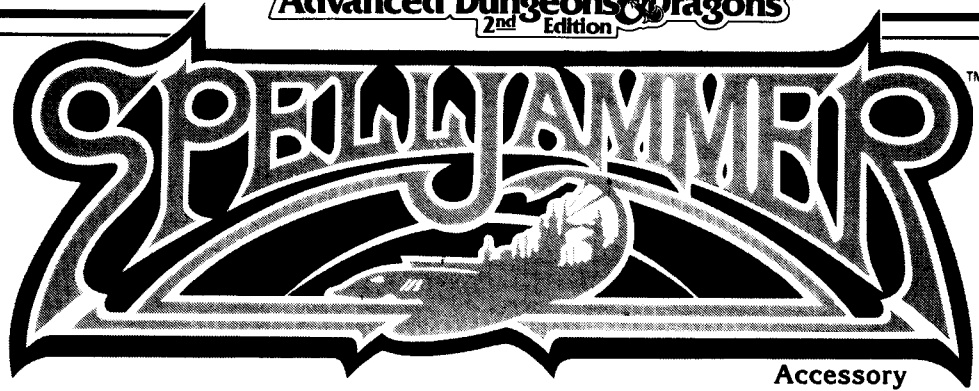

Accessory

Lost Ships

Table of Contents

How To Use <i>Lost Ships</i>2	A Guide to Sidebar Subjects	
New Rules3	Space Spores.14
Adventures:		Battle Spiders16
Part 1: Beginnings.7	The Sea of Shadows34
Part 2: Amid the Stars.13	Diseases38
Part 3: Any Port In A Spacestorm29	Scalykind Employers42
Flotsam of Space33	Slaver Gear44
Ship Catalog39	The Sargasso of the Seven Stars48
New Spells69	The Steel Star56
Personal & Ship Equipment73	Redeyes.62
New Monsters84		

CREDITS

Design: Ed Greenwood
Editing: Paul Jaquays, Anne Brown
Mentor: Jeff Grubb
Cover Art: Brom

Illustrations: Dell Barras
Cartography: Diesel
Graphic Design: Stephanie Tabat
Typography: Gaye O'Keefe

Dedication:

To Jeff, for opening The Box of Delights again.

This one's also for the too-often-unsung ones whose care and attention to detail make all TSR products better—Karen Boomgarden, Mike Breault, Bruce Heard, Kim Mohan, Jon Pickens, and Steve Winter. *Te salutant!*

Distributed to the book trade in the United States by Random House, Inc., and in Canada by Random House of Canada, Ltd. Distributed to the toy and hobby trade by regional distributors. Distributed in the United Kingdom by TSR Ltd.

ADVANCED DUNGEONS & DRAGONS, AD&D, SPELLJAMMER, PRODUCTS OF YOUR IMAGINATION, and the TSR logo are trademarks owned by TSR, Inc. Printed in the U.S.A.

©Copyright 1990 TSR, Inc. All Rights Reserved.

This material is protected under the copyright laws of the United States of America. Any reproduction or other unauthorized use of the material or artwork contained herein is prohibited without the express written permission of TSR, Inc.

Any questions on this material should be sent, along with a self-addressed, stamped envelope to, "SPELLJAMMER Game Supplement Questions," at the address below:

TSR, Inc.
POB 756
Lake Geneva
WI 53147 USA

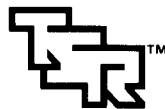

TSR, Inc.
PRODUCTS OF YOUR IMAGINATION™

TSR Ltd.
120 Church End, Cherry Hinton
Cambridge CB1 3LB
United Kingdom

HOW TO USE LOST SHIPS

Welcome to *Lost Ships*. Um—largely because he wants me to, let me introduce the eminent Old Mage of Faerun himself: Elminster.

(Hem.) So you have; thank you, my boy. I shall endeavor not to waste this shining chance to set straight those who have opened this book, and now dream grandly of high adventure amid the stars—hurling dread spells, righting dark wrongs to save worlds, and all that . . .

Now where was I? Oh, yes. Setting ye straight. (Hem.) Are ye listening? Well, WHY not? That's better.

So here it is: Lost Ships—ninety-odd pages full to the very margins with adventures, new monsters, magics, and spaceships! Swords high and gadzooks! Now, what does one DO with it, anyway?

Well, be ye first advised that this sourcebook is a supplement to SPELLJAMMER™: AD&D® Adventures In Space. Monsters, ships, and rules in that wondrous work are referred to so often herein that this cannot suffice without the SPELLJAMMER boxed set itself.

Secondly, the DM must read this book through before using it. Consider the effects of introducing these powerful enemies and treasures into the lives of your Adventurers. Each adventure herein should be modified to best suit your campaign.

Thirdly, space is vast. Give a thought or two to the direction ye wish your campaign to take. Prepare some encounters, enemies, and worlds before play begins.

Lastly, don't think that just because this foolish young man has allowed me to speak to ye now, that ye need use this only with the Realms—or indeed, with Oerth or Krynn or any world not of your own choosing! The sky is no longer the limit! The stars be thine!

Hi. Me again. Suddenly quiet, isn't it? *Lost Ships* provides 'usable ideas,' rather than a series of tournament-style encounters.

We start with get-'em-into-space scenarios to introduce *SPELLJAMMER* supplement into an 'earthbound' AD&D game campaign. Each of these forays best lends itself to the specified range of PC levels.

The adventures that follow range widely over space, involving many opponents and ship types.

The *Total Party Levels* listing is a rough guide to an adventure's difficulty. Adjust the challenges according to the group's playing style and the differences between current PC levels and those given. Changing monster hit points and numbers is generally preferable to giving NPC aid, but do what is best for the campaign. If monsters are altered, don't forget to change the *Monster XP*.

The *Total gp XP* listing gives the total gold piece value of treasure. Gems are figured in, but the total never includes resale prices for equipment, ships, and magic items. Such prices vary in space even more than on a world.

Each *Monster XP* listing has three entries: *Kill*, *Defeat*, and *Retreat*. These are based on monster experience values, modified subjectively to reflect the encounter's tricks and traps. Divide the appropriate total among participating characters to best reflect the involvement and achievements of each individual.

The *Kill* listing is used when PCs slay all opponents. Such a 'clean sweep' is even more difficult in space than on most fantasy worlds (and more unlikely in campaigns that concentrate on roleplaying rather than character advancement). This entry might not be awarded often.

The *Defeat* entry is likely to see the most use. It is appropriate when PCs win out over opponents, but cannot destroy them all (for example, when a monster successfully escapes).

The *Retreat* number applies when the party must abandon combat and retreat. It recognizes that PCs learned from the encounter, but

could not bring off a victory. Do not use *Retreat* if the PCs sight a foe and flee without engagement, or cleverly escape detection, avoiding contact. It applies when battle is joined and the PCs lose.

These entries are not ironclad dictates. Often party performance will deserve an experience total somewhere between *Retreat* and *Defeat*—when, for instance, most PCs are disabled or forced to flee, but the monsters are in the same straits, and both sides break off the fight. Neither scores a clear victory.

In the same manner, situations will occur in which an experience total between *Kill* and *Defeat* is deserved. For example, a situation all too familiar to players in my own campaign (and to many whose characters face foes able to *teleport* or travel the planes): the party defeats monsters decisively, destroying most but not all and a survivor escapes with the most important loot. The party is robbed of total victory and deserves to do better than they were allowed. It's hard to destroy a foe that need not stand and fight, even one you could otherwise defeat handily.

Each adventure opens with a *Setup* feature: an outline of a way the adventure can be introduced into play. Think up a few alternate ways that PCs can get to the Set Up before play begins. If the PCs head away from the chosen encounter (and the DM is unwilling or unable to abandon the adventure for the time being) consult these alternatives. One could offer another way to head back into the adventure without being too crude or unbelievable about it.

So, read on. Change this, chop that, lift an encounter here and put it down there . . . and above all—enjoy! (You wouldn't want to disappoint Elminster, would you?)

This section introduces optional rules to help in specific 'dodgy' space situations. Feel free to ignore or modify them, or substitute 'house' rules—but if so, consider why each rule seemed necessary, and why it appears here in this form.

Drifting Characters

Attack Penalties: Beings drifting in space attack at -2 unless they have *Spacefaring Proficiency*, are native to space, or are considered 'trained' or better crew. Movement without strong gravity or solid surfaces to push against is awkward for those unfamiliar to such conditions. A violent movement (e.g., attacking, signaling, or trying to catch something) may cause a being to head in the opposite or a random direction—and perhaps into danger.

Grabbing Things: Attempts to grab thrown lines and nearby floating objects (such as a weapon one has lost), can be adjudicated by requiring the being to make a successful Dexterity Check.

For large, massive objects, allow a $+2$ bonus. For objects offering ready handholds allow a $+1$ bonus. Penalties of -1 or -2 apply to things that are slippery, less than hand-size, or tumbling in space.

If two beings both grab for the same object, each makes an attack roll. The higher roll wins possession.

Adapting to Space

Some beings cannot cope with the utter lack of 'up' and 'down' or visible boundaries in wildspace, and suffer "space sickness." This may account for the rarity or lack of certain creature races in space.

If the DM desires, consult the optional *Space Sickness* table on the first occasion in which a groundling being loses physical contact with a ship or other large physical body and

drifts in space.

First-time space travelers should make a Constitution Check upon leaving their native atmosphere. Failure will also indicate a d100 roll on this percentile table.

Space Sickness Table

01-07: Space Catatonia: Affected being curls up into a ball, entering a natural *feble-minded* state (AC10), regardless of surroundings or situation. This condition may be chronic, lasting until a normal means for curing *feblemind* spells is applied; or be acute, a series of short attacks (1-4 turns lessening to 2-5 rounds), becoming a *Nausea* result and eventual cure.

08-16: Disorientation: Affected being flails about wildly, without control over direction of drift. Panic and instability make handling complex gear or performing complex tasks (such as spellcasting, dealing with knots or locks, aiming missiles, and the like) impossible. Penalize hand-to-hand attack rolls by -5 and Armor Class by 3 points.

This condition lasts 2-5 rounds, and may recur any time the being drifts freely in space until the being is acclimated. This acclimation period equals 20 minus Constitution days (counting only days in which the being drifts freely).

During this time, the being must make a Dexterity Check each time he attempts an attack, grabs for another object in space, or other complex activity (as above). Failure means the being begins to tumble. Tumbling continues until a successful Intelligence Check is made (checking once per round). A Tumbling being is penalized as above.

17-29: Nausea: Affected being is violently sick, has a -2 Armor Class penalty, and can launch no attack or spellcasting for 1-3 rounds. After that, he functions normally, but the

condition can recur (with identical recovery process and acclimation period) as for *Disorientation*.

30-36: Control Problems: Affected creature is *slowed* (as the third level wizard spell) for 2-5 rounds, but can function normally thereafter. Condition may recur within acclimation period (as for *Disorientation*), whenever creature suffers either *fear*; more than 6 hit points of damage from a single attack; or begins tumbling in space.

37-00: No Ill Effects: After 1-2 rounds of queasiness (-1 initiative), the being functions normally.

DMs may wish to apply any of the above conditions as a penalty for beings with space experience who get into trouble for some reason.

These effects are recommended for use in any drawn-out, complicated space melees, particularly after the breakup of one or more hostile ships scatters still-active, still-fighting combatants across space.

Proficiencies

DMs who use proficiencies in their campaigns may like to introduce several new ones. All space proficiencies are considered general.

Spacefighting: Beings do not suffer an attack penalty while adrift in space, and instead gain a $+1$ Armor Class bonus in situations in which they can drift freely (i.e., when not grasped by an opponent), simulating their ability to move in space to avoid attacks.

If this proficiency is used, it *must* be chosen initially by spaceborn characters and *its effects must be given naturally to experienced spacefaring monsters*, not just to Player Characters. Groundling PCs may not begin their space careers with this proficiency; it cannot be taught while on a world.

Boarding Pike: This governs use of the boarding pike (see the *Concordance of Arcane Space* rulebook, under "Personal Weapons and Ammunition"). It is initially available only to spaceborn beings. Groundlings must learn that such a pike cannot be used to hook and yank when boarding, unless one yearns to be a helplessly-snagged target.

Grappling Hook: This governs the use of the space grappling hook. Marine sailors who have grappled ships and thrown lines may have this proficiency when they start their space careers. Otherwise limit it as a starting proficiency for beings native to space.

Wheel Lock Pistol: This weapon is widely known only in space. As a starting proficiency, its use is restricted to the spaceborn. Learning the proper use and care of a wheel lock takes time. Those who master it can *repair* and improvise replacement parts for the weapons, not merely fire them well. They know how to react to a backfire so as to suffer only 1-3 points of damage from such a mishap, not the usual 1-6.

SPACE PROFICIENCIES

Proficiency	# of Slots	Relevant Ability	Check Modifier
Spacefighting	2	Int	+1
Boarding Pike	1	Dex	+2
Grappling Hook	1	Dex	+1
Wheel Lock Pistol	1	Dex	+2

Rope Rules

Striking Lines: Striking a tightly-stretched rope or rigged net causes a fast-moving being in space 1d4+1 damage and deflects the being's course. A Strength Check must be made to avoid dropping held items in such a collision.

Slack lines cause reduced damage, and drifting tangles none at all. This rule does not apply to slowly-drifting bodies.

Grabbing Lines: If a fast-falling being tries to grab hold of a rope, it must succeed at both a Dexterity Check and Strength Check. The grab attempt takes the place of the being's attacks in that round.

If a falling being makes one but not both Checks, its movement is considered to be greatly slowed. A being striking a line can try to grab it in the same round, but suffers impact damage first.

Swinging On Lines: A being who successfully grabs a tight or anchored line can, in the same round, swing on the rope and let go, to change direction. Loose or freely-drifting lines cannot be used in this way. A Dexterity Check determines if the being lets go at precisely the right time to end up on the desired course (otherwise, he 'misses' the release).

Use the 'scatter diagram' on page 63 of the *Dungeon Master's Guide* for adjudication of missed "Grenade-Like Missiles" to decide where a 'missed' being goes. Except in cases where contact with another object occurs, or the rope is severed or struck in mid-swing, beings who mistime when they let go end up at results 4 to 7 on the diagram (8-10 is the intended course). Beings native to space or having *Spacefighting* proficiency who 'miss' can end up only at 6 or 7.

Swinging Out On A Line: Beings who use anchored ropes (e.g., part of a ship's rigging) to swing out into space must make a Strength Check to hold onto the line at the height of their swing (or earlier, if they strike something first).

If a being tries to strike or grab-rescue a drifting target, an attack roll is required, and a subsequent Strength Check if the attack is successful, to see if it held onto the line on impact with the target.

The DM may require that several Dexterity Checks be made to *miss* undesired obstacles if a being swings

out into a debris field or into a melee of fast-moving beings or ships.

The DM must judge what any mid-swing contact does to the trajectory of a swinging line. In a contact with a large, solid object (such as a radiant dragon or a ship), the line's swing will probably come to an abrupt halt!

Throwing Lines: Success at throwing a rope to a drifting being requires that the rope have more velocity than the being (typically it needs a weighted end), and that the thrower succeed with an attack roll.

If the roll fails by 3 points or less, the drifting being still has a chance to grab the rope, which is considered to be nearby. The drifting being must make a successful Dexterity Check. If it fails, the being can try again next round. If that fails, the being can never reach the rope unaided, though the rope may be pulled in for another try.

Fired Lines: The accuracy of rescue lines attached to ballista bolts or other missiles (a spear or even a staff can be fired from a ballista) fired past a being and dragged back past the being can be determined by an attack roll of the ballista-gunner.

On a 20, the drifting being has actually been struck (and is caught fast; he or she may be easily reeled in, but must take damage).

If the attack roll is not a 20, but counts as a "hit," the being avoided the rescuing missile, but successfully grabbed its line.

If the roll "misses," the line may be reachable. The drifting being gets two tries (see 'thrown line' above).

Armor Class While On Lines: Beings on lines suffer a -1 Armor Class penalty against missile attacks (no penalty for attacks that come from beings drifting or on lines).

Cutting Lines: A drifting or "Ship Shaken" being trying to cut a line must make a Dexterity Check each round. If it fails, a cutting attempt could not be made that round—the

rope was missed or the cutter lost control of the cutting implement or his own stability.

Cutting attempts do normal weapon damage minus 1 (count all improvised weapons as *knives* for damage purposes) per attack. Only one cutting attack is allowed per round, despite the number of attacks the being is normally allowed. It replaces all other activities.

To cut any line, damage must be concentrated at a single point. Sawing a line with a blunt item or by rubbing it around a sharp bend or at a knot requires triple the usual (2-5 hp) damage to achieve a break—and usually takes triple the time.

Tying Knots: A drifting condition doubles the time required to tie a knot or secure a shipboard line: from 1 round to 2 rounds for experienced crew, and from 2 rounds to 4 for green crewmen.

Space Combat Rules

Ship-to-Ship Leaps: When a groundling being leaps from one ship to another, switching gravity fields so that its 'down' direction changes, a +6 initiative roll penalty and a -2 attack roll penalty applies to the leaping being for the round of switchover only.

It is lessened to a +2 initiative and no attack roll penalty for beings with *Spacefighting* proficiency.

Shipboard Gear: Loose gear on a ship jarred by a "Ship Shaken" result, hard landing, or ramming is both endangered and dangerous.

Fragile items (such as glass containers) are readily shattered during such 'heavy running.' A DM can require important items (such as potion flasks) to make a saving throw whenever a shipboard being holding or wearing them takes a tumble, or the ship is shaken, holed, rammed, or broken up.

Almost all spaceships are de-

signed for gravity plane shifts, and most or all gear is fastened down or secured within stout containers. This rule governs instances when items fly around ship interiors—particularly when player arguments must be avoided, as when a vital magic item, gem, or material component is bouncing about, pursued by two or more combating beings in an enclosed space inside a shaken ship.

The DM should decide the damage flying gear will do according to its nature—typically 1 point of damage for all fist-sized or larger solid, heavy objects, or per cloud of smaller objects; 1-3 to 2-5 dmg for larger furniture, such as chests and chairs; and normal damage minus 1 for unsheathed, free-flying weapons.

Beings in an enclosed area may face attack rolls from free-flying gear for 1d3 rounds. These can be rolled at THAC0 15 (16 or 17 if beings can move freely to avoid oncoming gear in larger areas).

A being making a successful attack roll against a piece of gear is assumed to have caught it safely, and may stow it on the following round—if a safe cupboard, pod, or net exists to stow it in—or may throw it into another area, perhaps endangering someone else there).

A more dangerous (but fun) way to rule on gear hits is for the DM to roll a d20 and the player to roll a d20: if the player rolls higher, the gear misses. If the DM rolls higher, the gear hits (tie rolls miss).

Spelljamming Rules

Control Contact: A being spelljamming a ship may retain control of the ship when engaged in personal combat (i.e., if attacked hand-to-hand) as long as any part of the spelljammer's body remains in *direct physical contact* with the seat of the helm. However, full speed is possible only when a spelljammer is seated



firmly in the helm.

An intruder who touches the helm or even sits in it while the original spelljammer maintains direct physical contact with the helm, does not and cannot wrest control of the ship from the original spelljammer—that can only be done by breaking the original spelljammer's helm contact or slaying him.

A spelljammer must be seated in the helm in the normal manner, however, to 'see' space around the ship—if a spelljammer is only touching the helm with an outstretched hand, for instance, he is 'flying blind,' with all the perils that entails. These include possible collisions and a dangerously lowered steering accuracy. A ship can veer up to 45 degrees away from its intended course both horizontally and vertically, under a spelljammer's misdirection—without the spelljammer noticing. If this occurs in relatively empty wildspace, there may be no way of getting back on a sure course. A ship can end up far from its intended destination—perhaps in a locale without needed air-replenishing atmospheres.

Multiple Power Sources: If different sorts of helms (e.g., series and spelljammer) are activated in the same ship at the same time, none will work, and all beings attempting to use or direct the helms must save vs. Spell or be instantly *feble-minded*.

A second magical power source cannot be activated on a ship in which a magical power source is already operating; the second source will simply not function. The only exceptions to this are the dreaded 'helm-bombs' (see "Personal & Ship Equipment").

Non-magical power sources may be used on a ship which is also being powered by a magical power source, but they will not affect its handling or speed—and are in fact, simply wasting their fuel. They can even prove dangerous if the magical power source suddenly ceases to function:

a ship may then suddenly surge sideways into another solid body, or suffer a "Ship Shaken" critical hit as the non-magical engine thrusts in a reverse direction from the stopped magical power source.

Reavers using a Space Leviathan hulk or planetoid cavern as a lair sometimes deliberately use this 'sideways surge' tactic to yank their ships suddenly out of view of pursuers or snooping intruders. It is never safe or sensible ship-handling, however (Don't try this at home).

Spelljammer Debility: This rule is suggested for use when a spelljammer remains at the helm during close combat (waiting to snatch the ship away).

If a 'Spelljammer Shock' critical hit result occurs, roll a die. An even result means "Debility." An odd result means that Spelljammer Shock (see the *Concordance of Arcane Space*) happens.

For every two Hull Points of damage dealt to a ship, the spelljammer of that ship (if still at the helm, 'connected' to the ship) suffers a 1 hp loss and an immediate 1-round-long period of intense, debilitating pain. The spelljammer shudders violently, suffering a 3 point Armor Class penalty, and is unable to spelljam or launch attacks (including aiming magic items).

The spelljammer can speak (or scream!) and try to ready weapons, potions, or the like for use in future rounds, but must make a successful Dexterity Check to avoid dropping such items. If the items are in a pouch, pocket, or scabbard, another Dexterity Check is required to get them free.

A spelljammer whose ship suffers 1 Hull Point of damage during the round in which the critical hit occurred would not suffer any debility, but if in a later round the same ship suffers 3 Hull Points of damage (for an overall total of 4), the spelljammer *immediately* loses 2 hp and is

disabled for 2 rounds. A single-round loss of 7 Hull Points causes the spelljammer a loss of 3 hp and 3 rounds of debility, and so on. These losses are restored by rest and healing, and will not of themselves cause 'Spelljammer Shock.'

Ship Handling Rules

Crash-Dives: Ships that are totally disabled or have no one at the helm fall to the surface of a world, heat up, and catch fire as explained under "Matters of Gravity" in the *Concordance of Arcane Space* rulebook. Ships deliberately sent into a dive are not "uncontrolled" unless the crew leaves the ship or are unable to man the controls.

Even the steepest dive will not cause a ship to catch fire if someone is at the helm. The heat buildup and vibration caused by atmospheric friction can be felt in the ship. Minute changes in the angle of descent can avoid the fire and keep the ship plunging at unabated speed. Attempts to cause the ship to flame will not work. Such an act causes *Spelljammer Debility* or "Spelljammer Shock" to anyone trying to spelljam a ship into flames.

This rule allows beings to turn a ship into a fiery missile if they bail out more than a mile above the impact site. It prevents beings with high hit points or fire resistance from deliberately riding a ship down to a fiery impact with a ground target, dodging and avoiding obstacles and attempts to divert the ship, yet keeping it ablaze for maximum damage.

Three Adventure Hooks For Getting Into Space

The adventures in this section provide ways of introducing the sprawling SPELLJAMMER™ space adventure setting to an ongoing 'earthbound' AD&D® campaign. The boxed text selections are designed to be read aloud to the players.

The DM may want to choose elements from all three adventures and add some original ideas to create an introductory adventure tailor-suited to the flavor and power level of his campaign.

I Must Go Up to the Stars Again

Terrain: Worldbound (mountains recommended)

Total Party Levels: 48 (8 characters of 6th level average)

Total g.p. X.P.: 14

Monster X.P.:

Kill: 7,030

Defeat: 5,273

Retreat: 1,758

Setup

While emerging from a dungeon on a remote mountainside, PCs notice strange, rusting, metallic wreckage among the rocks—most of which lies in a long, thin, curved shape similar to a large ship!

The Adventure

The wreckage is a surprisingly intact 'tradesman' ship. Constructed of stout wood treated with a baked mud-slayer as fire retarder, and later armor-plated with metal, it has been preserved by the plating, which has taken the full fury of the elements over the long years it has lain here.

The armor plating is worthless, and will crumble if handled (and fall away entirely if the ship moves). The

surviving trader ship is identical in statistics to the ship described in the SPELLJAMMER™ rules, except that it has no intact, repairable weapons left—only twisted wreckage. If PCs enter the wreck to investigate, read the following:

The wreck seems empty of cargo, and is festooned with small, growing molds, mushrooms, luminescent lichens, and hanging creepers. Small birds flutter away as you approach.

Exploring PCs will find empty chamber after empty chamber, connected by doors that stand mysteriously ajar. PCs will notice signs of battle: charred holes burned in wooden bulkheads, twisted and blackened metal panels and controls, and buckled floor-plates. This strife happened long ago.

As the PCs explore deeper, the gloom intensifies. The occasional rat or snake scuttles or slithers aside.

Dirt and dead leaves and moss lie underfoot. Silence reigns as you notice a faint orange glow coming from somewhere ahead.

Deep in the ship the PCs find a room lit by strange amber radiance.

The flame-colored light shines from a dark, high-backed chair carved from a single piece of stone. A skeletal figure with long, gray-white hair slumps in the chair, clad in the mouldering tatters of a once-fine gown and clutching a black rod. At its feet gleam scattered gold coins.

The skeletal figure is an archlich (described in the "New Monsters" section of this book), Sharangar Szeltune, who was once a 19th level archmage. Read this when the PCs are close enough to see her clearly:

The corpse seems to stare at you, its head cocked slightly to one side. Suddenly two points of rapidly expanding, glittering light appear in the dark eyesockets of its shriveled, dead face. The skeletal figure speaks in a loud, dry voice.

"Welcome, adventurers. Put aside your weapons and speak in peace if you would—I mean you no harm. I've waited so very long for someone to find me. I'm looking for a few true adventurers—to become my friends."

Read the above text even if the PCs immediately attack the figure from a distance. All initial PC missile or magic attacks will be deflected or dissipated harmlessly before they reach the seated figure as they trigger, encounter, and exhaust a spell cast long ago, which englobes the seat in combined *shield* and *globe of invulnerability* spells.

If the PCs charge to the attack, Sharangar rises from her chair, using *repulsion* to drive them back, calling upon them to speak peaceably, not attack.

If the PCs renew their attack, she casts a *fireball* behind them and raises her rod to defend herself. From the dark shadows near the ceiling, Luth and Nuenlee, two skeletal bats swoop into the PCs' faces, to distract aiming and spellcasting. They have 4 hp each (1/2 HD each), do 1-2 points of clawing damage per strike (THACO 19), fly at 18 (MC: B), and can't be turned. Edged/pointed weapons inflict only half damage on them.

They will obey the lich unflinchingly until destroyed, will serve her as spies and guides, and will bring her weapons, items, and material components fallen from PCs (even snatching the latter—with a successful attack roll).

If combat continues, Sharangar next uses *cloudkill* on the PCs, resort-

ing to *prismatic wall* and *wraithform* to make her escape only if pressed.

The archlich prefers to have the PCs as willing allies, and fights with reluctance, repeatedly pleading for peaceful speech.

The chair is an operable *minor helm*. The glow is a permanent *faerie fire* that ceases only if the chair's magic is destroyed.

The coins (14 gp) are the only monetary treasure in the ship. They fell to the floor around Sharangar when her belt pouch rotted away.

Sharangar clutches a *rod of death* (described in the "Personal and Ship Equipment" section of this book). She is chaotic good, has 42 hp, and holds in her mind the spells listed here:

Level 1: *dancing lights, detect magic, detect undead, identify, magic missile x2*

Level 2: *darkness 15' radius, deep-pockets, detect invisibility, flaming sphere, fog cloud*

Level 3: *dispel magic x2, lightning bolt, Melf's minute meteors, wraithform*

Level 4: *charm monster, confusion, dimension door, enchanted weapon, minor globe of invulnerability*

Level 5: *cloudkill, cone of cold, feblemind, passwall, teleport*

Level 6: *anti-magic shell, chain lightning, repulsion*

Level 7: *delayed blast fireball, force-cage, spell turning*

Level 8: *mass charm, power word blind, prismatic wall*

Level 9: *temporal stasis*

No spellbooks are to be found in the ship—and without spells or companions, Sharangar has not dared to take the ship back into space.

Sharangar is determined to get into space again. She will fight the PCs to protect herself, and will animate any PCs she is forced to kill to serve her as a crew.

Sharangar's once-beautiful hair, now a mold-covered mane of gray

and white, clings to a shriveled, half-skeletal face. She speaks freely, with a quick wit and sharp tongue, but is very lonely and desires friendly companions again.

She will assure the PCs that she has no interest in slaying them, and would prefer them as friends. She in turn offers her friendship and the powers of the ship, *Sharangar's Revenge*, to reach the stars.

Sharangar can wax quite eloquent on the beauty, danger, and riches to be found in space. She will tell the PCs that she is determined to get to space again. If they don't want to accompany her, she will plead with them to spread her tale so that others will come and let her take to the spaceways again.

If the PCs accept, Sharangar tells them her story, and offers to fly the ship (she keeps spelljamming a secret at first) around the world on any single mission they want to undertake. Afterwards she will take the PCs wherever they want to gather equipment or friends. Then she will take the ship into space.

If the PCs seek to escape, the lich will not stop them—unless they try to take the ship away from her, whereupon she will fight ferociously. If they win clear, she will fly away sorrowfully in search of other adventurers. The DM should have the ship fly past the adventurers on future occasions.

Sharangar's tale runs along these lines (flesh it out in response to PC queries):

Sharangar is the last surviving member of a long-ago adventuring band—humans who sought fortunes in the stars when the civilization of Blackmoor was at its height on the Greyhawk of years ago. Sharangar's husband led them through many adventures in the deeps of space before unwittingly entering into a mind flayer ambush.

The illithids struck down her friends, one by one, using their mental powers. At last, she unleashed her

most powerful magics. Most of the illithids perished. Dying, she took the helm and directed the ship away.

The *Happy Gauntlet* (a name still painted on a hatch door deep inside the ship, although to Sharangar it is now *Sharangar's Revenge*) vanished from the spaceways.

She headed for a refuge world—the world where the PCs find her. On the trip she became an archlich by completing preparations she had begun earlier in her career.

Alone on an empty ship, her spellbooks and most of the ship's furnishings gone or destroyed, Sharangar grieved. All too soon she landed and began her long vigil.

She has gotten over her grief at the loss of her husband and her other comrades, but longs to know the thrill and joy of adventuring in space with trusted friends again. Nevertheless, she realizes that as a lich, she has cut herself off from ever associating with common folk again.

If the PCs get to know her, they will find Sharangar a motherly romantic and a loyal friend. Her knowledge of space and the worlds to be found in it is so dated as to be almost useless (although she knows where many places of power stood in Greyhawk, which are now lost and overgrown ruins), but she can think quickly and with clever insight (providing solutions, if need be, for those traps that inadvertently prove too difficult for the PCs).

Sharangar's aims in space are to gain spellbooks to replace those she has lost, to replace her shipboard weapons, to gain the friendship of the PCs and to see that they are enriched—and, above all else, *to slay every single stinking illithid she sees, anywhere and anytime!*

If the DM desires, however, the search for her spellbooks can provide an interesting future adventure—particularly if Sharangar is destroyed in a battle, leaving word of the whereabouts of her cache as a final bequest to the PCs.

Dark Magic

Terrain: Worldbound (large city recommended)
 Total Party Levels: As desired
 Total g.p. X.P.: Nil
 Monster X.P.:
 Kill: 3,420
 Defeat: 2,565
 Retreat: 855

Setup

PCs begin in any large city when they overhear an excited man in a tavern telling a friend about a strange blue-skinned giant who has left messages tacked to the doors of some local mages.

The man shows one to a friend—and to several other curious patrons, who crowd around to look (including PCs if they wish). The fine parchment bears the words:

"Riches and adventure beyond what this world can promise await those willing to spend the time and the gold needed to get them. I, Nephroon, sell the way. Seek me at The Horn of the Unicorn these next nine nights. I offer no danger to those who offer none in return. Come if you dare."

The Adventure

The vendor of adventures, Nephroon, is a member of that mysterious spacefaring race known as the Arcane.

He sells spaceships (dromonds with *minor helms* and locators aboard) to adventurers, outlaws, and those who fear for their lives.

Details of the Arcane, the ship, and devices mentioned are found in the SPELLJAMMER™ boxed set.

If the PCs go to The Horn of the Unicorn to contact the blue giant, they find no sign of him. If they ask any tavern staff about him, they are directed to the cellar stairs, where (after dark, each night) "the blue giant awaits all who seek him."

At the bottom of the stairs, magical *continual light* spills from a side-room. There, on a plain tavern stool, sits Nephroon, a twelve-foot-tall armored giant, a wand and a long sword at his belt. He politely greets all comers, and offers them a seat.

Twelve empty tavern stools face the giant. The stools are just within the room, 60 feet from the giant. A low, bare wooden table stands half way between the stools and the giant.

Behind the seated giant, curtains on a track have been pulled back to reveal the rear of the huge cellar, another 60 feet or so of dusty, cob-webbed emptiness, lined with large wine casks on both walls.

Before the curtains stand eight silent, motionless men in full plate armor, visors down, spears in their hands and long swords at their belts.

Nephroon's armor magically protects him against mental influence and controls of all kinds, poisons, all spells of third level and less, and provides him with infravision. By touching his belt, (a *belt of the Arcane*,) Nephroon can raise a *wall of force* twice a day, such a wall lasting for up to 4 turns (ending instantly, earlier, if he so desires) and stretching across the room from wall to wall and floor to ceiling. Refer to the "Personal and Ship Equipment" section of this book for more complete information on *armor of the Arcane* and the *belt of the Arcane*.

The eight guards are skeletons animated to the Arcane's will. Each is AC7, MV 12, HD 1 (7 hp each), THACO 20, and does 1d6 damage with either weapon. Their armor is enchanted to hold the skeletons intact until destroyed. Thus, each skeleton has in effect an additional 22 hit points (for a total of 29)—the armor will absorb that much damage before disintegrating to reveal the unharmed skeleton inside. The armor does not improve the skeleton's fighting skills or damage, but lets them move in utter silence, even when metal weapons strike the armor.

The Arcane's own armor, like that of the skeletons, vanishes upon his death, disintegrating into nothingness, and taking all of its magical powers and effects with it.

The Arcane reveals to interested persons (the PCs and perhaps an NPC merchant—or maybe a room full of ragged outlaws) that he offers to sell a magical ship that can sail the stars. He briefly outlines what can be found in space, and the cost, answering PC questions with only as much information as the DM wants his players to have.

The price is 115,000 gold pieces. Nephroon will take magic items in trade and overvalue these, to give cash-poor PCs a 'bargain.' He will also give PCs a location where they can reach him a month later, if they need time to raise the money. That future place (like this one) is a large, sturdy, flat-roofed tavern.

The Arcane: AC3 (armored); MV 12; HD 10; 71 hp; #AT 1; Dmg 1-8; THACO 11. He wields a *wand of paralysis*, but will use his powers of *invisibility* and *dimension door* to avoid combat if possible. He will appear utterly unimpressed by threats, and will calmly and quietly state his terms and do his haggling in seeming ignorance of any menaces offered him.

Individuals who repeatedly attack or try to rob him will be paralyzed and collected as slaves, being confined in *forcecages* within fields of magical *silence*: both effects caused by items which the Arcane goes "elsewhere" (i.e., *dimension door* to a hiding-place) to get. Captives will later be traded to mind flayers.

If no deal is made, the Arcane politely bids the PCs good fortune on this world, and apologizes for having wasted their time. Have NPCs accept a deal before the PCs' eyes, if the PCs seem reluctant.

If a deal is made, the Arcane asks the PCs to put their money on the table. He gets up, walks to the empty rear of the cellar, and watches them.

If they attempt to deceive or cheat him in any way, he smiles, ceases proceedings, and suggests calmly that they deal more honestly, or seek the way out at their leisure.

When the proper amount is on the table, the Arcane gestures, and the curtains are drawn closed by the armored guards. One guard goes to stand beside the table. The others remain in view by the curtains.

A breath or two later, the curtains part to reveal Nephroon standing beside a large, high-backed chair. Two guards pick it up and carry it to the PCs. They then pick up the table, money and all, and walk back to the rear of the cellar as the curtains close behind them.

The Arcane tells the PCs that this is their magical helm, and asks that they pick it up and follow him (He will at no time permit anyone to enter or hide beforehand in the curtained rear of the cellar. He produces the *minor helm* from 'thin air,' and disposes of the money, table, and the guards carrying it in the same way).

The Arcane leads the PCs to the roof, where a huge ship has appeared! His magic holds it afloat in midair just above the roof, cloaked in concealing mists above the night-shrouded city.

Accompanied by the six remaining guards, Nephroon directs the PCs to take the helm aboard and demonstrates how to fly the ship, spelljamming it around the countryside and then up into space. He will decline to use it in battle or to attack creatures on the ground.

When the ship is in wildspace, the Arcane tells the PCs (as much as the DM wants players to know) of phlogiston, crystal spheres, and portals, the creatures they may meet in space, and then asks if anyone with the PCs is a priest or wizard. If the PCs lack such a character, Nephroon informs them that one is necessary to pilot the ship.

He instructs any PC spellcasters how to spelljam, makes sure they

have some experience in doing so, and then directs them in how to land.

Just before the PCs land, or earlier if attacked, he says a polite "Farewell," and vanishes into thin air (turning invisible and going to another part of the ship to magically escape). The guards calmly climb overboard and fall from view. Their armor disintegrates, so that only bones clatter to the ground.

The PCs are left with a ship of their own. The blue giant should turn up again if they listen for word of him, perhaps in another city, and will be ready to sell a *major helm*, a new ship, or any gear they can afford. Bear in mind the difficulty of dealing with the Arcane if the PCs harm or kill one of their race.

Further Adventures

Evil mages, illithids, or established PC opponents who learn of the PCs' dealings with the blue giant may try to follow and rob the PCs—or deal with the Arcane themselves and follow the PCs into the stars, stealthily following them and awaiting a chance to attack the PCs when they are weak, embattled, or scattered! Their aims could be to seize the PCs' ship and goods, and either maroon them on a planetoid, or sell them (i.e., to illithids or neogi) into slavery.

THE FALLEN STAR

Terrain: Worldbound (wilderness recommended)

Total Party Levels: 96 (8 characters of 12th level average)

Total g.p. X.P.: Nil

Monster X.P.:

Kill: 37,890

Defeat: 28,418

Retreat: 9,473

Setup

A great 'falling star' blazes its way across the night sky, crashing to earth near a lake, firing the trees

where it lands. The nearby PCs see and hear this.

The Adventure

Investigating PCs will find a smoking furrow gouged in the earth, as long and as far as a mounted man can see while standing in the stirrups. This landing-scar leads to a crashed starship, which lies partly visible amid smoking trees: a blackened metal hulk, scraped bright in spots like a soldier's cook-pot.

Half sunken into the earth, it has the shape of a huge spider, with oval hatches on either side of the forward 'head' section. Each hatch has an inset wheel of bars (shaped like an asterisk). If these are turned sufficiently, the door will sigh open, revealing darkness within, as a whiff of cinammon-scented air escapes.

The large ship is almost entirely empty—stripped of weaponry, cargo, and even crew (Refer to the SPELLJAMMER™ boxed set for floor plans of a neogi mindspider).

The circular, dome-roofed bridge holds the only things of interest. The spice smell emanates from the patchwork of soft fur pelts that line the walls. Inside squats a monstrous, bloated spider. Its tiny limbs curl uselessly against its fishbelly-white sides, high off the floor beneath it. Faded streaks and mottlings of red, orange, and moss-green mark its body. A thin thread of purplish fluid runs from a rent in its belly. As the PCs watch, dark, glistening eyes swivel towards them. It hisses softly.

The split in its abdomen grows wider, and spidery legs can be seen waving within it. A three-foot-tall spider scuttles out—and then another.

The giant is a Great Old Master. It will give birth to seven young neogi, even if slain by the PCs before all have emerged (Note: The Old Master's bulk will protect neogi young within it from spell attacks until they have fully emerged).

The Great Old Master cannot

move, although it can absorb a lot of damage before dying. Any adventurer foolish enough to climb atop it or venture in front of it will find that its head can still whip around like lightning to bite them—a process it's become very, very good at.

It is AC5, MV 0, HD 20 (151 hp), THAC0 5, and bites once a round for 1d12 damage. The bite of this not-quite-mature Great Old Master still retains its slowing poison.

A bite does physical damage and confers effects equivalent to a magical *slow* spell, lasting 1d8 rounds. Later bites on the same victim will extend this period of effect by an additional 1d8 rounds per bite. The Great Old Master has little intelligence left, and no magical ability.

Young Neogi: AC6 (their skins not yet toughened); MV 6; HD 5; hp 28, 26, 25, 23, 22, 19, and 36, in order of appearance; #AT 3; THAC0 15: two fore claws for 1-3 each, and a 1d6 bite with weak *slow* poison: the effects last only 1-4 rounds per bite. Aggressive and hungry, the young neogi will rush about attacking everything.

Behind the Great Old Master's bulk is a high-backed, broad, massive-looking chair, and beyond it another neogi: an Undead Old Master (detailed fully in the "New Monsters" section).

The Undead Old Master is a hairy, brightly-colored orange and green spider. Its flesh has begun to shrivel, and it exudes a faint carrion smell. Its eyes are sockets lit by ghostly lights rather than the black, glistening orbs of the other neogi. It is cunning and crafty, and is known to other neogi as Ulurth.

Ulurth: AC5; MV 3 (always in utter silence), HD 7 (hp 54); #AT 3; THAC0 13: two claws for 1-3 each, and a bite for 1-6.

Ulurth's undead state has robbed it of its poison, which its dead body cannot produce. However, the touch of its claws or jaw-mandibles *chills* living targets like the touch of a lich.

When Ulurth successfully attacks, the victim suffers an additional 1-2 points of cold damage, and must save vs. paralysis or remain motionless on the following round (the *chill* lasts only a single round, but if Ulurth successfully attacks the victim again during that round, it must save again to avoid paralysis on the *next* round, and so on).

Ulurth can devour things, but no longer needs to eat, drink, or breathe, and can now see in the dark. It has all the usual undead spell immunities, and turns as a "Special." Ulurth retains the spellcasting abilities it had in life—the equivalent of an 8th-level wizard. The Undead Old Master hides its spell book in its stomach, spitting it out only when it needs to study. Ulurth has memorized its maximum number of spells (chosen from the DM's favorite spell lists).

The spellbook contains 15 1st-level spells, 12 2nd-level spells, 11 3rd-level spells, 11 4th-level spells, and four 5th-level spells. The DM should choose spells focusing on attack and defense magics.

To get at the spellbook, the PCs must cut Ulurth apart. The Undead Old Master will not bring the book forth or hint at its existence.

None of the 5th-level spells are usable by Ulurth yet, though it has a fair idea of what each can do.

Upon seeing the intruding PCs, Ulurth manipulates a stud set in the floor. An iris-portal dilates and six umber hulks emerge, the last of Ulurth's servants (their heads should be rising into view as the PCs first see the chair and Ulurth behind it). Four surround and protect the Undead Old Master. The weakest two rush to attack the intruders.

The umber hulks emerge from a modification added to the latest mindspider models: a triple-walled 'crash hold' built below the bridge, between the ship's leg mountings. It sheltered Ulurth and his servants during the landing. Ulurth emerged

before the PCs reached the bridge.

Umbur hulks: AC2; MV 6 (dig: 1 per turn through ship decks and bulkheads); HD 8+8 (hp: 64, 61, 57, 55, 54, and 53); #AT 1; Dmg 3-12/3-12/1-10; THAC0 13. Meeting the gaze of an umber hulk causes *confusion* to all but neogi, and the creatures have 90' infravision.

Ulurth directs its slaves to slay the intruders and feed them to the neogi young—with so few hatching, it wants as many as possible to survive.

If the battle goes against them, the hulks retreat back behind Ulurth, who directs the next strongest pair of umber hulks to attack, while he and the other four try to corral a neogi or two and make for the exit.

Since the exit is the way the PCs entered, a confused melee will likely result as both the hungry umber hulks and the ravenous young neogi chomp on PCs in search of a ready meal. Ulurth won't help matters by unleashing its spells hard and fast into the fray, caring nothing for the fate of the umber hulks, but trying to avoid destroying the young neogi. Preparing a floor plan and figurines beforehand will help run this encounter with a minimum of confusion.

Every round that an umber hulk misses two or more of its attacks, the DM should roll a d20 for it. If the result is 11 or lower, the umber hulk loses its balance and falls thunderously to one side, perhaps into one of its fellows (or a PC). It will lose one claw attack on the following round in the process of getting up—unless someone is stupid enough to jump onto it, in which case it gets full attacks at +1 to hit, but doesn't try to get up.

The chair Ulurth was hiding behind is a *Lifejammer* helm. A dead human male lies shackled in it, white and drawn. *Speak with dead* on the man, a fighter named Beorl Whitehelm (from whatever world the DM wants) will reveal to the PCs as much as the DM wishes about spelljamming and space, as well as what he

was able to observe of Ulurth's story (about as much detail as given here).

Something is between the corpse and the back of the chair, propping the dead man upright. If the PCs draw it out, they will find a leather satchel. Inside are two plain metal plates held together by a strip of dried, withered skin wrapped around them and tied tightly. Between the plates is a page obviously torn from a spellbook. On it is the spell *create minor helm* (detailed in the SPELLJAMMER™ boxed set). In the excitement, Ulurth forgets this, but if the PCs prevail and the undead neogi survives, it will assume the PCs have it and make repeated attempts to regain it.

DM's Background:

The renegade neogi Old Master, Ulurth fled from death in this ship. Having a natural aptitude for magic, it studied and practiced all it could find (especially spellbooks seized from captured humans). As the years passed it advanced its magic to the equivalent of an 8th-level wizard. Not wanting to die in agony as a Great Old Master, Ulurth spent years researching undeath.

Many umber hulk slaves and lesser neogi died in Ulurth's experiments, until it found a human mage's process for achieving lich status. After destroying the result of the experiments, it became undead itself.

Then Ulurth chose a rival neogi Master to become a Great Old Master in its place, duping others into biting the wrong neogi by means of capturing and dyeing the hated rival to match its own skin markings, and using dye to simplify its own.

When the unfortunate's transformation was well under way, Ulurth seized control of the work crews stripping a mindspider craft for its transformation into a broodship, feeding them all to the ravenous Great Old Master.

Ulurth seized control of the ship and fled into space, using a human slave to power the Lifejammer helm.

Unfortunately for Ulurth, the supply of umber hulks to feed the Great Old Master proved too few, and its brood would be small. Moreover, the human spelljammer, weakened by the helm, died just before the ship landed, causing it to crash.

The Great Old Master, injured in the rough landing, begins to give birth as the PCs enter the ship. Ulurth plans a great revenge upon its rivals. It wants to repair the mindspider and build other ships to return to the stars when its slave neogi have control of this world.

From the spellbook of a human mage-slave captured in a spacefight, the Undead Old Master tore a single page, containing the spell its future neogi slaves would need, so that their human slave crews can power their ships into space.

Future Adventures:

If the PCs seem about to prevail, the renegade Undead Old Master will seek to escape, guarded by its umber hulks. Ulurth will hide in the wilds and scheme for years to enslave this world's most powerful rulers, working 'behind the scenes' through its agents, to achieve this end. It will regard the PCs as its greatest enemies on this world, and seek to destroy them whenever possible.

Ulurth's neogi rivals are looking for it, too, and may land to find and destroy it—or may wait for any ship that leaves this world.

If the PCs try to pilot the ship into space themselves, using the Lifejammer, or try to use other magic to move it around the world, its damaged state will cause an immediate crash. Make this spectacular and embarrassingly public.

As the dust settles, a cloaked, blue-skinned giant (an Arcane), guarded by two unfamiliar wizards

and six archers (hired adventurers) appear. The Arcane (who will give his name as Galadon) offers to get them out of any immediate trouble the crash has caused (healing PC damage, repairing broken things, settling damage claims, and so on).

Then he will offer them a trade: the wrecked, unusable mindspider ship for a spaceship that *will* fly, and take them into space! The Arcane will explain as much about space as the DM wants the players to know, not neglecting to mention its riches and wonders, of course

The Arcane will shrug if the PCs refuse his deal, calmly leaving his name and a place he can be reached if they change their minds. His guards will defend him efficiently if he is attacked (they are all 14th-level, with full hit points and spells).

If the PCs agree to his bargain, the Arcane will smile, nod, and wave his hand, whereupon the mindspider wreck will vanish (he makes it invisible to take it away for later study)! He then directs the PCs to a small pond entirely crammed with an intact galleon (fully armed and equipped with a *minor helm* as described in the SPELLJAMMER™ boxed set rules).

PCs may be most surprised to find it there, if they've come this way just previously! There is no way to move the ship by water from its location—it must be flown. The Arcane will wave and vanish at this point, even if the PCs try to ask him about moving the ship or other details of space, himself, or the neogi they fought earlier.





The adventures in this section are everyday encounters that can give a SPELLJAMMER™ campaign color and life between the major incidents, challenges, and goals that the DM establishes.

Slither Around the Sun

Terrain: Wildspace
 Total Party Levels: 80 (8 characters of average 10th level)
 Total g.p. X.P.: 6,000
 Monster X.P.:
 Kill: 9,960
 Defeat: 7,470
 Retreat: 2,490

Setup

While in an asteroid bar, PCs overhear a tipsy, incautious man telling an excited tale of a ship he'd seen in orbit around a certain star—a ship that floats in a protective cloud of beholders! *"They never leave it,"* he

whispers loudly. *"So what I think's, whatever they guard must be pretty special! If only I had me a good ship and some stout swords to sail it, eh? Then I'd see, eh!?"* Later, in space, the PCs notice a single large, dark ship of an unfamiliar type in close orbit around a star. Around it floats a cloud of things: spherical things—things with eyestalks!

The Adventure

Twelve spherical creatures float around the dark ship. Each has a large central eye and many small, moving eyestalks. The creatures notice the PCs, and turn so their central eyes gaze steadily at the adventurers.

If the PCs approach, the creatures react alertly. Most will drift into a cluster facing the PCs, but sentinels remain on other sides of the ship to prevent attacks from other directions. If the PCs come no closer and

make no attacks, the guardians will do nothing more.

If the PCs advance, however, the spherical creatures will suddenly dart at them, eyestalks writhing.

Streamers of smoke drift constantly from the ship, as if it is afire! Through the smoke, PCs can see it is large and spindle-shaped, tapering at nose and tail, and studded with bumps or 'blisters.' Two pairs of stubby wings protrude from the ship's flanks, one midship and the other just behind it. The ship is matte black in hue, with neither insignia nor distinctive markings.

The ship is a large orbiting scaly-kind egg-incubator known as a 'bloatfly' (see the "Ship Catalog").

The guardian creatures are space spores (a species of gas spore), magically controlled by an observing lizard man watchman. The watchman uses a *crown of the void* to maintain a continuous air envelope around the spores, and controls their move-



Space Spores

One particular species of gas spore, native to many spheres in space, does not affect any reptilian life forms.

All non-reptiles suffer the usual gas spore effects when encountering the rhizomes of space spores, but lizard men (as reptiles) do not.

Lizard men actively hunt space spores on some worlds and in wildspace. It is rumored that some jungle worlds are used by lizard men as space spore farms. On these worlds, herds of the dangerous creatures are nurtured by the scalykind for use in the making of weapons.

Lizard men craft glass grenade-like globes filled with space spore rhizomes for use in space combat.

Spacefaring adventurers are warned that space spores resemble some beholders very closely. Those who stick around to identify what they've met almost always find that they've tarried too long.



ments by means of an *orb of remote action* (both magical items are detailed in this book's "Personal and Ship Equipment" section).

DM's Background

The intelligent spacefaring lizard man (or "scalykind") tribes build these large, ungainly ships to further the intellectual development of their race by providing ideal hatching conditions for their offspring. Heat from the nearby sun bakes and melts the ship's black-tarred metal skin, producing the streamers of smoke and creating a hazard for intruders trying to cling to the ship's hull). Inside, the eggs remain very warm as they float in the fetid, flowing, nutrient-rich swamp water in the ship.

Lizard man slaves are greatly prized, so the scalykind have taken to guarding egg shuttles very heavily—but in doing so have stretched their resources so thinly that broodships themselves are surprisingly lightly-guarded.

An enterprising lizard-king hit upon the idea of using space spores as 'minefield' defenses to deter reavers desperate enough to try to seize a bloatfly just to get their hands on a ship. At great loss, a few beholders were captured, slain, and transformed into undead "death tyrants." These horrors were sprinkled among bloatfly spore guardians—and the scalykind made sure that word got around when a carelessly arrogant illithid reaver crew came to shocked grief in an encounter with one. The DM may wish to hide a death tyrant—or a living beholder hiding from some feud—in the next space spore 'minefield' the PCs encounter—or even this one!

PCs touching a bloatfly's hull must make a Dexterity Check for every contact or each round of continuous contact. Failure means a slip that causes either a fall away from the hull (if a second Dexterity Check,

made immediately, fails) into space, or an impact with the hull—and 1-2 points of damage from hot tar, plus possible damage to fragile or flammable items.

All movement on the outer hull is precarious; attacks are made at -1 and Armor Class is penalized by 2. In addition, any character who has slipped once suffers a -4 penalty when making subsequent *thrown* missile attacks due to sticky tar on hands and missiles affecting release times when throwing. This can be corrected only by wiping hands in alcohol, lamp oil, or lizard man ichor—nothing else will entirely remove the stickiness.

Intruders who get past the space spores will be attacked furiously by as many ballistae as the lizard man guards can operate (these are left loaded and tight-winch, ready to fire, at all times). Each 'blister' on the ship's exterior conceals two swivel-mounted ballistae, loaded and fired by one lizard man and turned and aimed by another, using a stout pulley and pull-rope arrangement and an array of wooden pull-handles.

Intruders who reach the ship must face the perils of the hot tar and force an entry through one of the guarded circular hatches. Inside each hatch are three glass 'grenades' full of space spore rhizomes, which the lizard men will hurl at anyone trying to enter. If fire or lightning spells are hurled into the ship, these glass containers must make the appropriate saving throws—if they shatter and a cloud of rhizomes is released, the DM should bear in mind that it will not affect the lizard men at all.

At each hatch is a rack of six cocked and loaded hand crossbows, which the lizard man guards will empty into any foes. On later rounds the lizard men will hurl javelins and fight with barbed darts and clubs.

The ship's crew consists of 16 guards, all 6th-level fighters of average intelligence, a war leader (9th-level fighter, of high intelligence), a

female 5th-level shaman, and a hired 16th-level human wizard. The shaman will use her magic without hesitation; the human has orders to hide and avoid combat.

The crew guards the precious eggs from intruders, sabotage, and from overheating or chilling. They shift eggs, introduce plants or bacteria into the waters or strain them out as necessary, close and open flow-gates in the complex system of piping, and even man primitive, bicycle-like mill wheels to pump water when rapid shifts in temperature are needed.

The ship is hot and very damp, the atmosphere thick with the choking odor of burning tar from the ship's hull. Intruders will discover that the interior of a broodship is entirely filled with a labyrinthine network of transparent glass piping, punctuated by small chambers where the guards store food, weaponry, the needed plants and spores for altering the chemical balance of the water, and larger swim-tunnels linking the rooms with the weapons blisters and the observation bubble.

Deep within the storage chambers are six wooden chests (one to a chamber), sealed with a cement of mixed mud and gravel to slow rotting. Each chest contains 1,000 gp for trading.

If interior piping is damaged during combat, guards will keep fighting—there is extra water enough to lose a little into the void. Gushing water or flooded rooms will not adversely affect the lizard men, although intruders of other races will not be so lucky.

Destroying eggs immediately enrages all lizard men who view the act or learn of it. They go into a reckless frenzy that gives them a +3 bonus on all attack rolls in each of the three subsequent rounds, but penalizes their Armor Class by 2 points during the same period.

Guards: AC5; MV 6(Sw12); HD 6+1, hp 44; #AT if unarmed (two claws for 1-2 dmg each, 1 tail-slash

for 1-6; a 1-hp bite is allowed if an opponent is so close to a lizard man as to be bitten and the lizard man is prevented from using one or more of its other attacks); THACO 15.

If armed, they attack as fighters (3 attacks every 2 rounds (special: four attacks per round with their barbed darts). All wear baldrics with 15 darts (30' range, 1d4 dmg), three javelins, a 2-8 dmg club, and a dagger.

War leader Sszgorl has 9+1 HD, 70 hp, and has THACO 12. He is armed with five javelins (no darts), a one-handed bastard sword, a dagger, and a *battle axe* +2.

The female shaman, Iliphistree, fights with a club (2-8 dmg), and is HD 5+1 (36 hp). She has the following spells when encountered:

Level 1: *command*, *create air* (detailed in the SPELLJAMMER™ boxed set), *cure light wounds*

Level 2: *flame blade* (x2), *hold person*

Level 3: *dispel magic*

Iliphistree carries two *potions of healing* in steel vials at her belt and a scroll containing the spells *animate dead*, *dispel magic*, *flame walk*, *hold animal*, *pyrotechnics*, and *speak with dead*. Iliphistree is enamored of Sszgorl, and he of her; neither will back down an inch in combat for fear of endangering or letting down the other.

The mercenary human mage is one Alaphon "the Listless," a lazy, shy individual who wanders about humming and muttering to himself (usually re-enacting some argument he lost—only this time, he's giving himself all the 'killer lines' he should have uttered to crush, humble, or impress his foes.

When excited or scared (in battle, for instance), Alaphon begins to sing romantic ballads—loudly, badly, and with great fervor and repetition. This does not prevent him casting spells, however; it does serve to annoy everyone within earshot.

Alaphon (AC8; dexterity bonus) is a thin man in plain robes. Most of his

spellbook is filled with scribbled lyrics and song ideas. He has only the spells listed below in the book. Hidden in one of his care-worn black boots is a secret steel vial with a *portion of extra healing*. He is terrified of Iliphistree and somewhat in awe of Sszgorl, and detests the "brutes" (the other lizard men). He will hide, but if found (presumably by victorious PCs; although if a PC thief sneaks off during the fray to pilfer things, he should encounter Alaphon humming atop the first chest of coins), Alaphon fights in a terrified frenzy, naming the PCs as reavers and dangerous ruffians who stand between him and any chance of payment for this boring duty—hired wizards are paid when they get 'home' to a lizard man world.

Alaphon's duties include casting *glassteel* spells and minding the ship's orbit by means of the helm, correcting any drift too close or too far from the sun. Alaphon has the following spells at his mental command:

Level 1: *color spray*, *identify*, *magic missile*, *read magic*, *spider climb*

Level 2: *continual light*, *detect invisibility*, *invisibility*, *levitate*, *web*

Level 3: *airsphere* (detailed in the "New Spells" section of this book), *dispel magic*, *fireball*, *fly*, *lightning bolt*

Level 4: *dimension door*, *ice storm*, *minor creation*, *polymorph other*, *polymorph self*

Level 5: *cloudkill*, *hold monster*, *passwall*, *telekinesis*, *wall of force*

Level 6: *anti-magic shell*, *chain lightning*, *create minor helm* (see SPELLJAMMER™ boxed set)

Level 7: *delayed blast fireball*, *force-cage*, *power word stun*

Level 8: *glassteel*

Roleplaying Alaphon: play him as an amusingly wacky, terrified-rabbit sort of guy—who can be very dangerous when cornered. He has the *airsphere* spell and the hidden potion for his own safety, and will not hesi-



Battle Spiders

These magically-animated, spider-shaped constructs have no monster entry, for each successive one is usually better than its predecessors.

Battle spiders have infravision and can detect invisible creatures (60' range for both). They obey these commands (repeatedly and in any order):

STOP—(any current action);

COME—(accompany commander);

GO—(Indicated direction and distance or named location; can be combined with other orders; i.e., things to do there);

GO AND BACK—as above, but includes return.

CARRY—(touch indicates what; limit one object at a time, no larger than M-sized and 600 lbs; Spider uses non-fighting claws);

DROP—(currently carried objects only);

ATTACK ALL—(living only);

ATTACK ALL BUT—commander touches all beings not to be attacked, or describes races, sex, types, colors, and size to be ignored.



tate to unleash fire and lightning among the ship's twisting, webwork of pipes—he cares nothing about the survival of leathery, green-white lizard man eggs, anyway!

Future Adventures

In this bloatfly ship, a waterborne monster has grown from tiny beginnings, when accidentally put among the egg cargo. If the PCs are weak, most of the lizard men could be busy fighting it at the time of the adventurer's approach . . . or it could break out to attack the victorious PCs! Use a small dragon turtle, a monstrous giant gar, a mud-man, or any other favored wet monster (add its XP Value to PC experience awards).

Also, in this or any lizard man ship encounter, include dangerous (i.e., carnivorous) plants among the many grown on interior ceilings and bulkheads to regenerate the air.

Death Spiders of the Thurdle Mage

Terrain: Wildspace

Total Party Levels: 112 (8 adventurers of 14th level average)

Total g.p. X.P.: 3,210

Monster X.P.: (caged monsters not included—XP varies with DM selection)

Kill: 90,800

Defeat: 68,100

Retreat: 22,700

Setup

The PCs hear of a mysterious group of mages who offer a wide variety of untamed, captive monsters and dragon eggs for sale. If they investigate, no mages are to be found, but a grizzled old human cargo-loader will say that the mages will be on their ship, usually to be found orbiting the dead world of Ambereye.

The Adventure

If the PCs approach the mage-ship too closely, its catapults suddenly fire giant metal spiders at them! The metal spiders will strike the PC ship and begin tearing at its weapons and superstructure, attacking any living beings they see.

The spiders are magically-animated metal constructs (see Battle Spiders sidebar). Each has 30 + 1d8 hp.

Only these mages know how to make battle spiders, but have yet to design a way for others to control them.

Beside the four spiders launched at the PCs' ship, another 12 wait as guardians aboard the mages' ship.

The ship is a standard issue *ogre mammoth* (see the "Ship Catalog"). It has been fitted with a *major helm* and its "slave holds" filled with many cages for the monsters that the mages capture.

No further battle spiders will be fired, but the mages will fire their ready-loaded ballistae at any characters who try to pass from one ship to the other. If the PCs flee, try to ram, or grapple, the ballistae will be aimed at any visible PCs.

Other battle spiders attack boarding PCs, backed up by the mages' spells. The mages will retreat into the ship if pressed, fleeing entirely if defeated, leaving their ship's defenses to fight the PCs.

Four spacegoing human mages:

Zamrakh, 11th-level: AC4 (*bracers*); hp 38; LE; spells 4,4,4,3,3.

Darsin, 8th-level: AC7 (Dex); hp 27; NE; spells 4,3,3,2.

Cormarr, 5th-level: AC9 (Dex); hp 21 (Con); LE; spells 4,2,1.

Archmage Olph of Thurdle (the ship's master), 20th-level: AC2 (*bracers*); hp 76; LE; spells 5,5,5,5,4,3,3,2.

Olph denies magical weaponry of any sort to his three apprentices, and is himself armed with six *beads of*

force, a scarab of protection, and a wand of frost, fully charged.

The important or unusual spells carried by all of these wizards are given at the end of this adventure. Remaining spells should be chosen from among the DM's favorite magics.

For security reasons, none of them carry their spellbooks into space. They have 10 *potions of extra-healing* and eight *teleport without error* scrolls hidden in niches and behind panels around the ship for escape back to Thurdle, their hidden stronghold on a nearby planet.

If any of the wizards survive an encounter with the PCs and flee, they will become persistent enemies of the PCs. The details of the wizards' stronghold in Thurdle are left to the DM.

None of his apprentices will betray him willingly—they fear the consequences and safeguards Olph has set around his expected death (these *contingency* related details are also left to the DM, but consider that they lead to the raising and restoration of Olph's body, so that he comes after the PCs for a return engagement).

The Thurdle mages are experimenting with a captive neogi, devising mechanical imitations. To fund their research, they sell monsters and rarities like radiant dragon eggs, staying briefly on worlds and moving about to discourage thieves and angry dragon attacks.

A variety of monsters in locked cages are aboard the ship. If released, they are as likely to attack the PCs as they are the wizards. Some of the wizards have *charm monster* spells memorized. Magic was used to capture the monsters, so many of them don't know who captured them (combat-damaged monsters don't bring top-market prices).

Suggested monsters are a mantico-re, a hippogriff, three myconids, six giant weasels, 12 urds, a giant stag beetle, an eagle, and four black bears. They are housed in widely separated cages (most of the 40 cages in

the hold are empty).

The three cages closest to the door into the holds are defective; if lifted up, the bottoms can be kicked off to permit escape. The wizards know this.

The monster area is guarded by three flesh golems, who attack any intruders except the four wizards, or those accompanied by one of them.

One cage, off by itself, contains the captive neogi. This cage is guarded by two more flesh golems (with identical orders as the golems mentioned above).

The neogi is tired, hurt (it has 28 of its usual 32 hp), and angry. It has no magical abilities, and doesn't how it came to be a captive of these men who periodically cut it open between periods of sudden sleep.

Consider using this as the PCs' first contact with a live neogi. If they 'rescue' it, it will turn on them savagely!

Three unlocked strongboxes can be found in a cabin. They contain the wizards' haul from their last sale of monsters, guarded by two more flesh golems. These creatures have the same orders as the other golems, except that one will ring a large bronze bell it holds (usually by striking it against an armored intruder).

One chest contains 16 cloth bags, with 100 sp in each. Another holds a wooden coffer containing 150 pp, and three stout canvas sacks containing 300 gp each. The last chest contains 14 neat leather tubes, each holding a 'roll' of 100 gp. This is the only monetary treasure on board.

The ship has ample food and water, a *major helm*, and two old-style, bulky, hard-fitted (i.e., bolted in, and hard to remove) Arcane devices: a *Locator* and a *passage device*. It has no star charts, markings, or any papers anywhere on the ship; the mages are very careful about that.

Olph's memorized spells are:
Level 1: *burning hands*, *identify*, *magic missile*, *shocking grasp*, *spider climb*

Level 2: *continual light*, *darkness 15' radius*, *detect invisibility*, *invisibility*, *pyrotechnics*

Level 3: *blink*, *dispel magic*, *hold person*, *Melf's minute meteor*, *wraithform*

Level 4: *charm monster (x2)*, *Evard's black tentacles*, *ice storm*, *minor globe of invulnerability*, *phantasmal killer*

Level 5: *animate dead*, *cloudkill*, *cone of cold*, *feblemind*, *hold monster*

Level 6: *chain lightning*, *monster summoning IV*, *project image*, *repulsion*

Level 7: *delayed blast fireball*, *reverse gravity*, *spell turning*

Level 8: *Bigby's clenched fist*, *Otto's irresistible dance*, *Serten's spell immunity* (Olph casts this on himself the moment any PC reaches the hull or enters the ship)

Level 9: *Bigby's crushing hand*, *shape change*

Olph will strike to disable and delay attackers and let the *battle spiders* fight or grab them; he's not interested in wearing down his magic items (unless in real danger) or destroying his own ship with magic.

Zamrakh has the following spells memorized: *detect invisible* and *charm monster* along with his maximum possible number of spells.

Darsin has memorized *charm monster* along with his maximum possible number of spells.

Cormarr has his maximum possible number of spells.

Death in the Mists

Terrain: Phlogiston

Total Party Levels: 48 (8 adventurers of 6th level average)

Total g.p. X.P.: 49 (shipboard)
+ 27,570 (lair)

Monster X.P.:

Kill: 10,280

Defeat: 7,710

Retreat: 2,570

(Note: if either Alaikyn or Derovin escape the PCs, "Defeat" is the highest that should apply.)



Battle Spiders are Fearless, AC 3; MV 14; save as Metal; #AT 3; Dmg 2-5/2-5/2-12; THACO 14. These attacks can do 1 hull point of damage per 10 hit points of accumulated damage directed at a ship. It has Strength of 21 (Included in damages given). Mental control and illusion spells do not affect it.

A battle spider carries out orders tirelessly until destroyed, dragging itself along with screams of protesting metal if damaged.

All battle spiders have 5 HD and an XP Value of 650. Neogi hate these rare human inventions and destroy them at all costs.



Setup

PCs find the dark, riven hulk of a neogi deathspider floating in the phlogiston. Thin cords are stretched across its decks and openings. Any creature which explores the ship's interior (which has been stripped) cannot avoid disturbing the thick webwork of cords which ring a warning bell when disturbed, alerting the Droon.

The Adventure

A clan of aggressive, crafty space-faring kobolds, the Droon, wait for victims to plunder.

The Droon sell slaves to illithids and others. Chief among these contacts are "The Black Blades Band," a small group of ruthless, heavily-armed giff whom the Droon meet regularly in the dark, silent Deadsun crystal sphere.

The Droon rob captives of all food, weapons, and valuables (even clothes for disguises). The Droon are hardened and bloodthirsty (increased morale: 12), and currently use a turtle ship in battle. It bristles with weapons (see "Ship Catalog"), but looks like a battered old trader, having been festooned with rusting debris and old, splintered wooden spars.

At first glance the deathspider looks like an abandoned wreck. The Droon carefully cover all signs of life and ready weapons until battle is joined.

When PCs approach the deathspider wreck, the turtle ship lurks silently in the mists until the Droon believe they can take the PCs' ship by surprise, ramming from the rear. Short Range Combat is possible before closest encounter . . . if the PCs notice the Droon.

If every PC fails an Intelligence Check and the Droon are not noticed, they will ram the party's ship squarely, dealing it 1 hull point of

damage plus the usual "Ship Shaken" and 1 other random Critical Hit.

Whether the ram is successful or not, the Droon will fire their three ballistas at PC crew members on the decks, and use their boarding pikes to pull their ship over to the PC vessel (The Droon attack also steals air from the PCs' ship, in passing). The Droon will then try a Shearing Attack along the decks of the PC vessel, sweeping aside equipment and crew alike, attempting to force the PC ship into a collision with the deathspider (alert PCs could board the Droon turtle ship at this time). The Droon ship has a medium catapult at its rear, loaded with stoneshot. It will fire this back at the PC vessel just after it passes over.

The Droon ship carries a crew of 40 kobolds. It has been stripped for raiding and contains plenty of food and water, 86 ballista bolts, 14 sacks of stoneshot, 7 full normal stone catapult-loads, 8 boarding pikes, and 40 light crossbows (each with 26 quarrels) and shields. All of this gear is securely strapped and stored.

There is also a well-hidden strong-box containing lots of empty canvas bags for storing coinage. One bag contains 46 gp, 5 ep, 4 sp, and 10 cp, the ship's "treasure."

The ship is fitted with a major helm (seized not long ago from a boarded human longship), and has its original *minor helm* set up deep in the aft hold. The ship also has a magical Arcane Locator device, but no star charts. The Droon pride themselves on knowing the space they operate in, and take care not to note anything that might help a captive learn the whereabouts of their treasure caches and hidden refuges (one is a remote valley high in the mountains of The Spine of the World, in Faerun on Toril).

At the helm is Derovin Blackthorne, an 8th-level human wizard, a LE 26-hp male. He is a full member of the kobold band (who trust him as

much as they trust each other). His spells when encountered are:

Level 1: *magic missile* x4

Level 2: *ESP, pyrotechnics, web*

Level 3: *fly, lightning bolt, wraithform*

Level 4: *minor globe of invulnerability, phantasmal killer*

Derovin is armed with three *dispel magic* scrolls (one spell to a scroll), a belt dagger and one hidden in his left boot, and two steel belt vials, each containing a *potion of extra-healing*.

Derovin's spellbooks are hidden at "Greenshield," a Droon base. This barren, fissured triangle of rock is in a debris-strewn sphere near Realm-space, and bears a thick cloak of opaque green mists—fouled air, caused by the slow release of sulphurous gases from the rock itself. The Droon hide food, water, another *minor helm* in a 'Dead Box' (see "Personal & Ship Equipment"), and some spare weapons here, all deep in different cracks, wrapped in canvas cloaks upon which a slimy-looking but harmless mold has been encouraged to grow.

Another base, a scattering of rock fragments drifting near Greenshield, is located on one of the point rocks of the crescent-shaped arc of tumbling asteroids known as "the Little Lights." Some of these small, lifeless, airless chunks of rock, devoid of useful metal content, glow with *continual light* spells, placed by some mage long ago. The Droon use one rock to hide their treasure, stuffing canvas sacks of gold pieces down a particular small hole (6,700 gp), concealed by a rock cap wedged in the hole above the gold. A nearby hand-sized fissure holds a small old, dark metal box (nearly invisible in its crevice), that contains the gem wealth of the Droon: six uncut bloodstones (5 gp each), 14 smooth-polished "tears" of rock crystal (60 gp each), and four fiery red, unusually large fire opals (each the size of a child's fist and worth 5,000 gp).

Derovin will try to escape in

wraithform if hard-pressed, stowing away in the PCs' vessel to get revenge, using his magic to strike down the PCs unawares, one by one.

The Droon are led by Derovin's long-time adventuring companion, Alaikyn Droon, a kobold of almost man-size (AC5; HD 3 + 1; hp 16; Dmg 1-8; THAC0 17), who is armed with four javelins, a handaxe, a shortsword, and an *anti-magic egg* (detailed in the "Personal and Ship Equipment" section; Alaikyn knows its command word).

Alaikyn is a kobold shaman (4th level priest), and has the following spells when encountered:

Level 1: *cause light wounds, cure light wounds* x2 (1-8 hp per spell, in all cases)

Level 2: *flame blade, withdraw*

Note that Alaikyn can turn undead like a 4th level cleric and that he is well aware of the danger of casting his *flame blade* while in the flammable phlogiston. Alaikyn bears a scroll at his belt in a wax-sealed metal tube. On it are the spells *create air* x3, *cure light wounds* x4, and *detect powers* (The first and last are found in the SPELLJAMMER™ boxed set).

Alaikyn commands 40 kobolds, all AC7, MV 6, 1/2 HD (3 hp each), THAC0 20, 1 attack for 1-6 damage. The Droon are experienced space fighters and work well together. Each is armed with a shortsword, 2 javelins, a dagger, and has a shield and a crossbow (see above) nearby. They will attack viciously, boarding the PC vessel if forced into a crash-landing, or if it has not moved to escape or evade when they return for their second pass.

At that time, Droon bands covered by loaded crossbows will attempt to reach the PCs' helm and seize it, or seize or disable the spelljammer (the Droon have no qualms about clubbing the spelljammer senseless, but will try not to slay such a valuable slave).

The Droon want to capture the

PCs' ship as a prize, with all beings and items aboard it. Failing that, they will try to capture all able-bodied beings (i.e., potential slaves) that they can quickly seize and get away, taking gear as a second choice, food and water being as important as magic or weaponry.

The unnamed Droon ship will try to escape to Greenshield. If Derovin has been disabled, Alaikyn can spelljam (SR of 2 if using *major helm*, 1 if using *minor*) as a kobold shaman.

If the Droon escape, arrange an eventual return encounter, bearing in mind that the Droon will not seek out the PCs until they (the Droon) are stronger in number and equipment than they appear in this adventure.

The Droon are not good at figuring out which seized items are magical and which are not—or how to use them. If one or more PCs become Droon captives, some entertainment (and opportunity for PC escapes) should result from comical Droon attempts to operate or identify exciting-looking captured gear.

Slaves of the Mist Princess

Terrain: Wildspace
 Total Party Levels: 96 (8 adventurers of 12th level average)
 Total g.p. X.P.: 3,000
 Monster X.P.:
 Kill: 45,900
 Defeat: 34,425
 Retreat: 11,475

Setup

While docked on land, the PCs are attacked during the night by a scorpion ship, which suddenly appears hovering overhead.

The Adventure

The PCs are under attack from one of the fast raiders of space, the infa-

mous Mist Princess, a powerful (18th level) sorceress. The pirates of the self-styled Princess use sleep-poisoned bolts in their crossbows.

The Mist Princess's ship is a standard warship scorpion ship (see the "Ship Catalog"), carrying slave cages in its hold.

The 36 pirates will fire their ship's loaded weapons as they approach the PCs. All are lawful evil except the Princess, Asril, and Yentra (see below).

They'll grab at the hull of the PCs' ship with the scorpion's ram-claws, and either grapple the ship or peel it open, firing with crossbows at all PCs who appear (describe what below-decks PCs could see and hear and do not reveal that the pirates are using sleep-poisoned bolts). The Princess will cover the pirates with her spells during the attack.

The Princess's pirates are as follows: 31 2nd-level fighters, all male, 16 hp each, THAC0 19, and armed with daggers (1d4), hand axes (1d6), and broad swords (2d4).

These pirates also each have three loaded hand crossbows when they attack. In the first round of close range combat, allow them two attacks at any on-deck PCs. The first volley of quarrels will strike before any PC attacks (ruining spellcasting). Each pirate has 16 quarrels in a leg quiver strapped to his belt.

Each quarrel does 1-3 damage, and the struck victim must save vs. Poison at -2. A successful save means the character is immune to the poison of all the pirates' quarrels; a failure means that the character will crumple to the deck in 2-5 rounds, falling into a deep, drugged sleep. This sleep cannot be broken by slapping or dousing with water and will last 1-2 turns.

The other five pirates are all human females, the Princess's lieutenants. They are:

Asril, 4th-level cleric of Tempus: AC 6 (scale mail); 26 hp; CN; THAC0 18 and armed with a mace (1d6 + 1)

and a warhammer (1d4 + 1). Asril's spells are: 3, 2, but they are lost for this encounter, as she has just been spelljamming the scorpion ship.

Delgarra, 6th-level fighter: AC 5 (chain mail); 52 hp; LE; THAC0 15; and armed with 5 javelins (1d6), a long sword + 1 (1d8 + 1), a hand axe, and two daggers. She will hurl (non-poisoned) javelins at the PCs at the first encounter, concentrating on whomever she deems a spellcaster.

Nethra and **Phylparr**, twin sisters who are both 8th-level thieves: AC 7 (leather armor and Dex bonus); 41 hp; LE; THAC0 17; and armed with sleep-poisoned daggers, darts, and hand crossbows (with 12 quarrels each; roll poison effects for all their weapon attacks). Both have black, waxed, 60'-long cords wound round their waists. The cords end in grappling-hooks. They will use these to trip or catch lone PCs, spoil PC spellcasting, or grapple a ship.

Yentra, a 4th level fighter who actually perished some weeks ago, and has been replaced by a doppelganger (none of the other pirates know or suspect this). "Yentra" is AC 5; MV 9; HD 4 (hp 30); N; THAC0 15, 1 attack for 1-12, saves as 10th level fighter, immune to *sleep* and *charm* spells. She has been acting sick for the past few weeks to cover up misstatements and her general slowness. She feels no loyalty whatsoever to the Princess or the pirates, but is not stupid enough to double-cross them openly in the midst of a battle.

The Mist Princess, 18th-level wizard: AC 4 (*ring of protection* +6 on AC, +1 on saving throws); 29 hp, armed with a wooden scimitar and four sleep-poisoned daggers (see above for effects); CE; THAC0 15.

She dresses in flamboyant, swash-buckling shirts, breeches, and bucket-topped boots. A *brooch of shielding* pins together the bodice of the Princess's open shirt, and a sphere in a purse at her belt is actually a set of *iron bands of Bilarro*, which she hurls if hard-pressed in

battle. A scroll stuffed in her belt bears the spell *destroy major helm* (see below).

As her ship prepares for the ambush, the Princess casts the following spells on herself: *protection from normal missiles*, *minor globe of invulnerability*, and *Serten's spell immunity*. The DM should keep track of when these will expire. Princess uses *teleport without error* as her "escape" spell. She'll abandon her crew without hesitation to save herself.

Her remaining spells are:

Level 1: *color spray*, *magic missile* x3, *spider climb*

Level 2: *blindness*, *detect invisibility*, *ESP*, *flaming sphere*, *web*

Level 3: *airsphere**, *blink*, *dispel magic*, *hold person*

Level 4: *ice storm*, *polymorph other*, *spark burst**, *wall of fire*

Level 4: *Bigby's interposing hand*, *cloudkill*, *flyfield**, *telekinesis*, *teleport*

Level 5: *chain lightning*, *destroy portal**, *disable helm**

Level 6: *delayed blast fireball*, *force-cage*, *teleport without error*

Level 7: *destroy minor helm**

Level 8: *create atmosphere**

All spells marked with an asterisk are detailed in the "New Spells" section of this book.

The Princess is immune to the poison used by her crew. A fiery-tempered lady of common birth (actually Elaena Whitebranch, born on a farm in Tethyr, on Toril—the Forgotten Realms™ campaign world), she came to space only a dozen years ago, but is determined to improve her lot.

A ruthless slaver who deals with the neogi (and is powerful enough to keep out of their clutches when doing so), the Princess desires to capture adventurers and sell them into slavery—they bring her richer booty (magic and lots of coin), and their enslavement removes potentially dangerous competitors or foes from circulation.

The Princess carries no magic items on her ship, beyond what is described in the character descriptions; she carefully and quickly hides these (consider creating adventures to describe and locate her treasure hoards). She does have three locked chests in her cabin. One is a trap; it contains three thirsty stirges (AC8; MV: FI 18(C), 1 +1 HD; 9 hp; THACO 17, 1-3 dmg + 1d4 blood drain per round, to a total of 12 hp drained each). The other two chests contain 1500 gp. Smart pirates do not bring treasure on voyages (their wealth is carefully hidden away on worlds).

Any PCs the Princess captures will be stripped, robbed of all valuables, and caged in the hold as the scorpion runs to the nearest prison asteroid (the Princess is never stupid enough to hold slaves where their friends, families, and creditors might be standing around).

Prison asteroids are small, off major routes (or surrounded by dangerous debris to deter casual inspection), and barren. It must have a cave or fissure in it.

The pirates hide their filled cages in the fissure, and the Princess casts a *create atmosphere* spell over them. Then she meets with a neogi agent, who quickly comes to pick up the PC(s).

Whatever the outcome of the PCs' initial encounter with the Princess, make her a continuing NPC in the campaign, a foe who doesn't mind drinking with the PCs in a tavern, securely surrounded by her well-armed crew—and then facing them over sword points in the void a day later.

Pharaoh the Stars than Thee

Terrain: Any space
 Total Party Levels: 144 (8 characters of 18th level average)
 Total g.p. X.P.: 16,050 gp (plus gems and other items, as valued by the DM)

Monster X.P.: (slaves not included)
 Kill: 40,400
 Defeat: 30,300
 Retreat: 10,100F

Setup

PCs exploring the farthest reaches of space come upon a strange object. It must be a spaceship, because it's moving—turning, in fact, toward them. It's a large stone pyramid!

The Adventure

Consult the "Ship Catalog" for details of flying pyramids. Some critical hit results are not applicable to these ships—the DM should select others when such results are indicated.

The PCs have found The Dark Pharaoh's Pyramid. It has standard armaments and unlimited ammunition (the undead gunners pry loose stone blocks from the walls as needed). It is powered by a *death helm*, so the Pharaoh is always in need of new slaves—such as the PCs.

The pyramid is crewed by 46 skeletons, 33 zombies, four wights (all standard versions, having full hit points in every case), two liches, and the Pharaoh himself. None of these undead can be turned or dispelled while they are in the pyramid. The Pharaoh can never be turned or dispelled by a being of less than demigod status.

The Pharaoh is an especially powerful mummy who retains the use of some of his clerical spells. In life he was a priest of Set—an evil Egyptian mythos god). The Pharaoh is detailed later in this adventure.

When the PCs approach, the undead Pharaoh is low on slaves. There are presently 16 slaves in the pyramid, weak from lack of food and water. All are humans; 14 are 1st-level warriors of 6 hp each.

One of the special slaves is a female human cleric of the Path and

the Way, Elonse. Elonse is 3rd level, and 19 hp (her full hp are 21). She presently has two *cure light wounds* spells memorized. The other is Uluarn, a NG 4th level human male fighter of 31 hp (36 at full).

The interior of the pyramid is one huge room, its walls banded with rail-less walkways leading to the weapon emplacements and empty side-rooms, formerly the burial chambers of the undead. The slaves are kept in two of these, sleeping in one and living in another (refer to the "Ship Catalog" for a diagram of a pyramid interior.) In the center of this vast chamber rises a small step-pyramid of fitted stone blocks. Its top is a square, 20 feet on a side, where the Pharaoh sits on his throne. The liches usually sit on the floor beside him, near the steps.

At the foot of one of the stairs is the *death helm*, its occupant always guarded by a wight. Open spaces for worship, audiences, and weapon repairs lie at the foot of the other three stairs. The room is weirdly lit by braziers (small and nearly doused, so as not to endanger the Pharaoh) smoking with incense, and by amber *dancing lights* drifting about.

The Pharaoh directs his servants to disable the PCs' ship and bring the PCs aboard. The Pharaoh wants not only them, but their magic and money. He greedily craves more magical power and exhorts in denying it to others who might use it against him. The money is used to buy those supplies or favors he cannot take by force.

Lastly, the Pharaoh wants another helm, one that his liches or living spellcasters can use, to reduce the slave drain (problems, problems . . . always problems).

If the PCs flee, the flying pyramid will pursue them tirelessly, even to a world, and attack. If the PCs enter the pyramid, the undead fall back to draw the PCs into a trap. The liches and the Pharaoh care nothing for the lesser undead, though destruction of

slaves is a direct insult to them, one to be coldly avenged. They will sacrifice skeletons and zombies without hesitation to gain a single magical item or living slave.

The pyramid's treasure is kept in a vault reachable only by mining (there are tens of feet of stone to dig through) or by raising the Pharaoh's throne, lifting the stone block it sits on, and descending on a rope or a wooden ladder down a 60' shaft.

The ladder is rotten and will break, causing a character to fall 50' unless a Dexterity Check is made to grab another rung. A second Dexterity Check must be successful, or that rung, too, will fall away.

The treasure chamber contains six guardian "jadesnakes" (spitting snakes, cf. "Snake" in the *Monstrous Compendium*) of AC5; MV 12; HD 4+2 (hp 30 each); 2 attacks per round: bite for 1-3 +poison, and spit poison 30' range; THACO 17.

The snakes lie half-buried in the piled treasure, waiting to attack. Gold and copper coins are heaped all over the chamber floor, loose and shifting underfoot (-2 to MV rate, -1 to AC when moving, due to slipperiness, for PCs only).

There are 16,050 gp, 112 sp, 6790 cp, and 4 pp in the chamber, but it would take almost *three uninterrupted days* to gather it and cart it away, let alone count it (allow a grabbed fistful of coins to be 9+1d4 in number and determine types later, gold predominating).

Mixed in with the coins are six ivory tusks (value as the DM desires); three mouldering, valueless pelts; a jewel-hilted longsword inset with three 5,000 gp rubies; a fist-sized sapphire (worth 9,000 gp), a pair of *bracers of defenselessness*, a pair of *winged boots*, a *chime of interruption*, a pair of *gauntlets of swimming and climbing*, and a *horn of bubbles*.

All other magic in the pyramid is carried (and wielded!) by the ship's inhabitants. The wights, clad in mouldering black priestly robes

edged with purple, are all armed with *staves of the serpent* (all of the "python" variety). Successful attacks with these weapons do not drain life energy: a wight must directly touch a living character to do that.

The two liches are Xiontarn and liileth, the faithful wizard-kings of the Pharaoh, serving him in undeath as they did in life. Each carries a *wand of magic missiles* (only 16 charges left in both cases) and a *wand of flame extinguishing*.

Their first duty is to protect the Pharaoh, dousing any fires on or near him. They obey him unhesitatingly, even to their own destruction (they have been promised that he can call on Set to restore them to their lichdom, and it may even be true). Consider their morale to be Fearless and their loyalty unshakeable, successfully resisting all mental or magical attempts to control them against the Pharaoh's will. In life they trusted and respected each other deeply, and loved their Pharaoh. There is no rivalry between them, and they work together as a team with the skill and familiarity of *long* practice. The locations of their phylacteries are left to the DM, to furnish possible future adventures.

Xiontarn was in a life a LE wizard of 23rd level, and has 46 hp. His spells are: 5,5,5,5,5,5,5,3.

His spellbook contains a number of spells equal to three less than he can memorize. It is hidden in a hollow block of stone, three layers deep in the stone blocks leading up to the Pharaoh's throne (when he wishes to study, it is no trouble to command skeletons to take up all the fitted blocks of the steps and put them back again).

liileth was in life a LE wizard of 21st level, and has 37 hp. His spells are: 5,5,5,5,5,5,4,2. liileth likes to use a *change self* spell to appear as a young female human slave and run toward intruders, crying for help; if touched, he can deliver a harmful spell requiring direct contact.

liileth's spellbook contains only a number of spells equal to the number he can memorize. It is hidden under a stone block on one of the walkways, upon which a brazier stands (a skeleton moves the brazier away, and another skeleton lifts the stone before liileth approaches the niche to get his book).

Make intelligent spell choices for these creatures. Remember, they are clever and have had ages to practice special magical tricks and tactics.

The Pharaoh is AC3; MV 6; HD 20+3 (hp 118), LE; THACO 5, and attacks once per round *as well as casting a spell if he desires*, by will and word only (no material components required).

The Pharaoh's attack does 2-16 points of damage, but its other effects are as regular mummies. The *fear* effect and fire resistance of the Pharaoh are the same as for mummies.

The Pharaoh casts spells as a 20th level priest of Set. Set does not entirely trust the Pharaoh and has not granted him any of the horrible spells given to priests of Set over the centuries. The Pharaoh's spells are: 9,9,9,8,7,5,2, and he is almost always fully charged due to his constant prayer, replacing cast spells as soon as possible.

The Pharaoh's current spells are:
 Level 1: *command* x9
 Level 2: *charm person or mammal*, *detect charm*, *hold person* x5, *know alignment*, *spiritual hammer*
 Level 3: *animate dead* x4, *call lightning* (this spell will work for the Pharaoh inside the Pyramid), *dispel magic* x3, *hold animal*
 Level 5: *cause serious wounds* x4, *sticks to snakes* x4
 Level 6: *air walk* x2, *cause critical wounds* x2, *flame strike* x2, *raise dead* (reversed: *slay living*)
 Level 7: *blade barrier* x2, *heroes' feast* (used from time to time to keep the human slaves alive), *speak with monsters*, *wall of thorns*

Level 8: *animate rock* (the Pharaoh will direct his skeletons and zombies to tear loose one of the large blocks of stone set into the floor of the great chamber before he casts this spell), *confusion*

The Pharaoh has a pot containing 32 sticks of wood beside his throne, for use with his *sticks to snakes* magics; they're something else he will direct his servants to scavenge from the PCs' ship. If the PCs get into the treasure chamber while the Pharaoh is elsewhere, he will create snakes and drop them on the PCs' heads.

If all of this seems a little overwhelming, the PCs should run! A good way to get the Pharaoh off their tails (a slave can suggest this, if none of the players think of it) is to sail across space until a neogi, beholder, or illithid ship is found (or preferably a fleet of such). Such aggressive and paranoid space races will always attack large ships like the flying pyramid. The Pharaoh, of course, will charge right into battle, and maybe the PCs can slip away.

Adventure Ideas

Some adventures must be heavily tailored to the specifics of one's own campaign to be successful. Here are a few that can be combined, twisted, or fleshed out to suit.

And a Star to Steer Her By

This is a good encounter to use early in the PCs' spacing careers. They find an abandoned wreckboat (see "Ship Catalog") somewhere in space. The ship is empty and lifeless. It has been stripped by earlier raiders, who have hastily torn the helm, Locator, weapons and ammunition from their mountings. PCs shrewd enough to search diligently through the wreck will find a dead spaceworm (see "New Monsters") slumped in a corner, slashed to ribbons. Beyond it

is a storage-cabinet with the door hanging open.

The cupboard is empty, but tacked to the inside of the door is a folded piece of paper: a crude star map, marking the way to some giff space, an eye tyrant wreck, an illithid base, and a pirate treasure cache, as well as the notes: "*possible Arcane storage on this moon*" and "*treasure here? Pirate destination.*"

Also taped to the map is a metal key—who knows to what? Something will turn up, possibly after the PCs have grown tired of trying it on every locked chest or door they find.

The Giff Stood on the Burning Deck

A band of giff have found and salvaged a turtle ship (see the "Ship Catalog" section) powered by an ancient furnace (into which they toss potions, daggers +1, and the like out of a crate of such goodies).

They are presently purveying a cargo of lamp oil among the planets and looking for trouble (and new items to feed the furnace).

They attack the PCs with lusty bel-lows "*Aaarr, there! Be ye but quivering meat under our guns! Harooo! Prepare to die, ye tame galoots! Ggg-grrrrr!*"

Their ship, the *Tierest Orlubar*, is proudly armed with the newest giff weapon: disposable guns and a modified gnomish "supersweeper" (see "Personal & Ship Equipment") in two of their ballistae, connecting two ballista bolts with a huge net for damaging ships. Furthermore, their tiny space base is guarded by asteroids connected by huge chains to entangle intruding ships.

Out in the Flow where the Big Ships Go

PCs encounter a drifting Barge of Ptah (see "Ship Catalog"), a burial ship inhabited by a demilich.

The demilich hides, avoiding combat at first. It uses *bone dance*, to drive away the PCs. The magic animates individual bones as clubs. Each bone attacks the nearest living thing until destroyed, striking once per round for 1d6 damage. The spell animates 16 bones (from earlier intruders), including 1d4 animated skeletal hands that rise intact, picking up fallen broadswords, to attack (for normal damage).

Each bone is AC7 and has 2 hp. If hit, it breaks into two smaller, 1 hp bones, which go on attacking (same damage, but struck hands cannot wield weapons). If struck again, 1-hp bones crumble into dust.

If the PCs pry open the door of the great chamber beyond, the demilich will slowly begin to rise (see Lich in the *Monstrous Compendium*). Any NPC with the PCs will scream and run, and it might be a good idea for the PCs to follow!

Porcupines Have Sharp Points

PCs come upon a derelict porcupine ship in the flow, abandoned by retreating goblins.

Goblin skeletons lie everywhere, their flesh and clothing eaten by spaceworms. A human skeleton is fixed to a beam by a fired spear-trap.

The ship is heavily trapped: spring-spears wait for intruders everywhere (see Ship Weapons in the "Personal & Ship Equipment" section). They are set up in pairs or triples: diving aside to avoid one trap moves one into the firing line of the next!

The ship holds no treasure except its intact *death helm* (see Personal & Ship Equipment), which has a human skeleton slumped in it. However, the goblins left behind a lot of locked, empty chests—each covered by at least three spring-spears!

Strike of the Shrikeship

PCs traveling in space sight a shriekship (see the "Ship Catalog") swiftly approaching.

It lets fly with its weapons as it closes. The reaver crew is composed of 26 wild-bearded berserkers (see "Men: Berserkers and Dervishes" in *Monstrous Compendium*). They leap to board the PC ship.

Their leader, a huge, hairy brute clad only in a loincloth, waves a huge iron bar and bellows, "*Strike, lads! Strike for Beldasker, and by my name, I'll reward ye!*"

Beldasker is a disguised ogre mage who controls the crew with the help of an evil young enchantress named Vauntra, who is an 8th-level wizard armed with a *wand of magic missiles* and a *potion of gaseous form*.

Vauntra spelljams the ship. If attacked, she will drink the potion and try to escape, firing with the wand to delay intruders. The enchantress, who has nearly full spells, will drift out the hatch opened by the ogre mage (see below) and seek to reach the PCs' ship, unobserved, where she will look for a hiding-place to stow away until the PCs' next port of call. She doesn't mind riding on the ship's underside, and won't take foolish risks.

Beldasker remains on his ship. If "his" crew appears to be losing the fight, the ogre mage disappears below, throwing iron bar and loincloth out a hatch into space. "Beldasker" disappears with them.

The ogre mage goes to the slave-cages in the hold of its ship, unlocks a cage, *polymorphs* into the shape of a disheveled human female, slips into the cage, slams the door, and hurls the keys down the hold to the entry door near the hook upon which they customarily hang.

In the guise of a helpless captive, the ogre mage begs to be rescued. An amulet hidden in "her" hair prevents reading of her alignment.

Given the chance, "she" leads her rescuers into an ambush by other pirates.

Starpoon!

When the PCs enter an unfamiliar crystal sphere, they are attacked by human barbarians riding kindori. The barbarians are standard AD&D® game warriors and wizards (their strength should challenge the PCs; details of such forces are given under Domesticated Kindori in the SPELLJAMMER™ boxed set).

The riders come from Sreen, a planet in chaos. During a war, mages on both sides opened too many planar gates and the world is now overrun by monsters.

Consider setting adventures from published modules, rules experiments, and things not wanted in the campaign's usual fantasy world on Sreen. PCs who visit Sreen may find crashed, wrecked spaceships with dead mages at the *helms*.

The kindori herd gathers around the moons of Sreen. Using tow harpoons ("starpoons"), goads, and holding-hooks, the barbarians have domesticated several young kindori males. At the DM's option, these may be magical, usable by unskilled PCs as well as the barbarians.

When the PCs fight the men from Sreen, lizard man whaling ships appear to attack the kindori, with the PCs caught in the middle!

A Ship of Stone is Best Left Alone

When the PCs visit an asteroid, this encounter can occur.

A clawed arm rises up from the solid stone underfoot and grabs a PC (grab the best fighter) by the ankle. Another PC (say, the most important spellcaster) is grabbed and hauled down a fissure in the rock. The other PCs must attempt a rescue!

They are attacked repeatedly by

arms and mouths lunging out of the rock—xorn arms and mouths. The PCs have landed on a xorn stoneship, literally a lump of stone flying through space (see "Ship Catalog"). The xorn fear dwarven attack and are determined to slay or drive off intruders. They try to take one PC as a hostage and slaughter the rest.

If the PCs give up and return to their ship, the kidnapped PC will be questioned, stripped of any magic, and released.

If the PCs then renew attacks, holes open in the stoneship and its weapons will fire. The stoneship's three recessed rams then slowly rise into place (in 3-6 rounds) with deep rumbling noises and ever so slowly, the ship begins to move

To Hunt the Moveable Feast

PCs come upon an open-topped drakkar (Viking longship) drifting in space. In it, a corpse can be seen, laid upon a bier, surrounded by weapons, shields, and strongchests. An unmanned helm rises behind the bier. This is obviously a burial ship, set adrift in space.

Its air is thin and smoke-scented, but clean. If PCs investigate the ship's treasures, they will suddenly find themselves under attack.

Nine orc warriors (all equivalent to "guards" as described in the *Monstrous Compendium*) hide under the bier, piled chests, and armor. They are salvage-raiders who pounce on anyone trying to explore the ship, seeking to capture or slay.

The orcs have survived in space thus far by means of a *crown of the void* (see the "Personal & Ship Equipment" section), the source of the ship's air. They are out of food, having just eaten their last captive. They capture victims to power the ship's *lifejammer helm*, and eat the bodies afterward.

Ghost Ship

The PCs find an empty deathglory (see "Ship Catalog") adrift in the flow, stripped of crew, helm, cargo, armaments, and all treasure (the DM should have such encounters from time to time, or PCs will come to expect every derelict they encounter is a prepared death-trap.) The ship itself is treasure, if the PCs think to or have the means to tow it.

A day or so later, the PCs will find another derelict: a swan ship (see "Ship Catalog"). No one is aboard, and there are no corpses or signs of a struggle. The air is good, and the standard helm, weaponry and ammunition are present and ready.

In one hold are lots of empty, unlocked cages, such as one uses to transport slaves (except that there are no manacles) or monsters. In another are six strongchests, one unlocked. They are all brimful of gold pieces—1,000 pieces each! So what happened to the crew?

The crew's been eaten, that's what. They were carrying a caged and drugged mind flayer captive to a world for questioning, along with treasure they had seized from him. (Unbeknown to them, the illithid had prepared a trap against thieves: one of his chests (the unlocked one) contains only about 60 gp. Underneath it, disguised as a pile of gold pieces, is a common mimic. One by one the crew was eaten—and once the mind flayer overcame the effects of drugs that missing crewmen were no longer administering, he spat out a hidden lockpick, freed himself, and mentally overcame the crew.)

They have been fed to the mimic one at a time, and are now all gone. The illithid has tried without success to modify the helm for its own use. It is trapped here, growing steadily more hungry.

When the PCs arrive, it hides amid a pile of spoiled, reeking food in the cargo hold of the ship, and waits for the mimic to do its work. It will stay

hidden and attack any lone PCs who explore the ship. The mimic, too, is wise enough to strike only at single PCs.

The illithid will try to get onto the PCs' ship undetected, to lurk as a stowaway, awaiting a better chance to strike. If the PCs take the "gold coins" from its ship (i.e., carry the mimic aboard), the illithid will try to make the crossover unobserved at the same time. The illithid and mimic have worked together as a team for a long time; aboard the PCs' ship, they will continue to do so.

The DM could keep them both as unseen presences aboard a PC ship for some time. Small, valuable items and food would constantly go missing, as would pets, captives, NPC hirelings, and so on (there's more than one way to create a 'ghost ship').

DarkViper

The DM can use this as an 'out of the frying pan and into the fire' rescue for endangered PCs in space. A sleek vipership (see "Ship Catalog") will appear to aid the PCs.

Afterward, the PCs will be invited to a pleasant dinner by the ship's captain: a handsome, drawling man armed with a jewelled *gemsword* (see "Personal & Ship Equipment").

He gives his name as "DarkViper," an obvious alias. He is a bored wonderseeker (see "New Monsters"), who has hired himself out as a bounty hunter—because in that profession, *others* find adventure for him! Dubbing his ship the "DarkViper," he has taken that name himself, and taken "a few commissions."

If the PCs attack him for any reason, he will exhibit the powers of a *necklace of missiles*, his *gemsword*, and a *ring of spell turning*, in making his escape to an *invisible*, towed wreckboat (see the "Ship Catalog").

He is aided in his escape by an iron golem. It will fling open a door into the room and breathe as DarkViper

runs right toward it, rolls under its legs, and disappears. The golem physically blocks pursuit (sooner or later the wonderseeker will be back, with another vipership and a score to settle.)

DarkViper doesn't plan any such strenuous activity on top of his fine food and wine. He merely wants to chat with the PCs, to find out exactly who they are.

That's because he's been hired by an old (planet-bound?) foe of the PCs, to capture one of them and bring him back to serve as a slave.

The DM should decide which one; if the PCs have come to rely too heavily on an NPC ally, he's the target.

DarkViper has extra weapons hidden all over his ship, and even an extra *major helm* stashed under his raised bed (if the mattress is hurled aside and the hatch beneath it opened, the helm springs upright, ready for use).

If no hostilities occur, DarkViper will bid the PCs adieu at the end of the meal, and part peacefully.

A day or so later, a neogi ship he tipped off about the PCs' location will pounce on the PCs.

The lurking DarkViper will watch for his chance and show up amid the confusion of battle in his wreckboat, seize the desired character and return to his ship.

He will try to do this secretly, working in disguise—so that afterwards he can offer to work for the PCs, to hunt himself down! (If he bumbled the first try at grabbing the PC, this gives him a second chance.)

"DarkViper," whatever the DM decides his true name and powers are, could prove to be an interesting continuing NPC in a SPELLJAMMER™ AD&D® campaign.

Grin of the Deathspider

To a neogi, the universe never seems to hold enough slaves—one always needs more!

PCs who are too curious about a drifting Angelship (in the "Ship Catalog") will find it to be full of slave-gathering traps for a young, ambitious neogi. Powered by a furnace (into which the neogi tosses potions), the ship travels into areas of space heavily traveled by humans, and then stops to drift lifelessly.

The neogi owner hides far down the tunnels that run through the Angelship's wings. Its six personal umber hulk slaves wait for intruders in all the ship's hiding places.

Their instructions are to wait until everyone in a boarding party is aboard, exploring the intact, fully-furnished ship and interesting-looking cargo (lots of empty, lashed-down crates and barrels), then block access to all exit hatches and close in. The umber hulks have instructions to disable, disarm, and knock cold, not kill—but they are allowed to slay if they must to protect themselves.

The neogi will not emerge until the hulks seem victorious. If the PCs prevail, the neogi stays in the tunnel depths, waiting a chance to escape or attack and overcome them. It knows the tunnels well, and has several places where it can retreat into a cavity and slide a metal plate in front of itself for concealment.

Quest for the Starmetal

Most human adventurers have heard the dreaded battle-cry "Dwarves . . . In . . . Space!" Few know that the evil duergar dwarfkin have recently reached the stars, too! Using human hammerships, dromonds, and fish-ships (whatever they can grab), the duergar have begun mining amid the stars.

After mining a ship-load of whatever metals are scarcest in their own lodes, the duergar hasten back to their worlds, crashing their stolen ships if they must and hurry underground.

On this occasion, spacefaring PCs come across "dwarves" (actually duergar) mining a metal-heavy asteroid. It is a misshapen rock about the size of an ogre mammoth ship (see "Ship Catalog"), veined with gold and gems—a valuable prize!

The busy duergar fill small, floating ore-skips moved from afar by a mercenary human mage wearing a *crown of the stars* (see the SPELLJAMMER™ boxed set). The mage empties the skips into a cargo hatch on a tradership on which he stands.

The duergar will use their innate *invisibility* once they realize that intruders are approaching, and crowd onto a single ore-skip, which the mage will bring back to the ship.

The level and specifics of the mage and duergar are left to the DM (the *crown of stars* and the mage's magic items and spellbooks should be a rich treasure if the PCs prevail). The duergar will throw their axes in a frenzy, and use the *crown* to ram ore-skips into drifting characters or the PCs' ship. They will do anything needed to drive off the PCs and then pursue: they don't want anyone coming back to steal their asteroid or spread the word of duergar in space.

Silent Stars Go By

Abandoned, wild elven ships are described in the SPELLJAMMER™ boxed set. Most will be empty of gear and a power source, and require a lot of work to be made spaceworthy again. But now and then the DM can introduce one that contains something useful.

In this case, PCs find an overgrown flitter hidden away in the flow, a dust cloud, or very thick asteroid belt. If they cut into its overgrowth with axes and swords, they will find an intact *major helm* inside. In it sits a skeletal elf wearing a *gemsword* (see "Personal & Ship Equipment") scabbarded at its belt, and a *ring of*

shocking grasp.

There is no sign of why the elven helmsman died. The sword has a distinctive appearance, and will be recognized by spacefaring elves the PCs meet later. They recognize it as the blade of the missing elven prince Riathor of Rauntavil, and will want to know (rather urgently) just where and how the PCs got it!

Too Big to Throw Back

Due to stiff competition with neogi for slaves, mind flayers must resort to all sorts of tricks.

On a long space voyage, the PC ship is attacked by a void scavver (see the SPELLJAMMER™ boxed set).

When the mayhem this causes is well underway, a second scavver cruises in—and then a third, while PCs are still fighting the second. A fourth and fifth show up together, followed by a sixth—upon which rides the mind flayer who has used its *charm monster* power to control these menaces.

The illithid wants the ship to go enslaving (preferring to keep at least a handful of PCs as slaves).

To avoid capture, it will seize a void scavver while one is still alive and ride back into space, plunging into the cover of a nearby dust cloud.

I Seek a Stone to Stand On

Dwarves sailing through space in ships smaller than their huge citadels are usually adventurers working with halflings, gnomes, or humans.

Purely dwarven bands encountered in this way (perhaps with a hired spelljammer aboard, or on a hired human ship) are searching for metal-rich asteroids, new planetoids to colonize (convert into citadels) or new supplies of "glowmoss" (see the "Personal & Ship Equipment" section) which they use to light their subterranean tunnels.

Some dwarves grow mad in space. The affliction known as "goldlust" on some worlds grows wild and strong, and such dwarves become more chaotic neutral than lawful good. They will sail right up to human, halfling, or elven ships and demand to be shown all the rocks that may be aboard. "*Aye! Rocks, ye idiot! Have ye never seen nor heard of rocks, then? I suppose ye've never heard of dwarves, now, either?*"

Such dwarves aren't really interested in worked gems or coins, but want to see every unworked rock aboard—and find out *exactly* where it came from, by bellowing questions at the crew. Woe betide the captain who has ballast rocks or catapult loads in his holds; every rock will be scrutinized and discussed.

Once they've learned enough, the dwarves will gruffly thank the captain and stamp back to their own ship. If they are not allowed to rummage, or are attacked, they'll whip out their axes and fight.

Spaceships of other races than the ones listed (and of course, other dwarven ships) will simply be attacked. They *might* have rocks on board, you know, and reasoning with such queer creatures is harder work than simply slaughtering them and looking for yourself!

Such mad dwarves are thankfully rare—but if PCs begin to throw their weight around in space, or seem too quick to attack ships that happen to pass near, the DM could well arrange to have a mad dwarf ship show up.

Then, of course, a week later, a second ship will heave into view, and *these* mad dwarves will want to know all about all the rocks *and* about the first ship—who was aboard, what they wanted, and so on.

A little mad dwarf encounter goes a long way. The DM can repay his long-suffering players later, however, when they really run into trouble, and are facing cold death in space—and a ship sails blithely up to the rescue, with bristle-bearded dwarves

aboard who squint at the PCs and say, "Ye again? So tell me, now—how'd ye get into *this* mess? And have ye picked up any rocks since last we met? Ye know—to hold down papers, and put under hot pots . . ."

The Sacred Firefall

PCs find a Shriekship in orbit around a world they've never reached before. It appears empty, lifeless. If they board to investigate, they find a robed man standing alone in the first chamber they enter. He regards them severely for a moment, and then smiles.

"*You've come at last,*" he says. "*Let it begin then, for the glory of the Firelord!*" As he speaks, the ship surges forward, and then its movement seems to slowly slacken. The man raises his hands to form a circle in an obviously ritual gesture, and then slowly fades away. He was only an image (physical attacks will pass through the image without dispelling it, and it will ignore all PC actions). The hatch by which the PCs entered (and all other exterior hatches) has been *wizard locked* by a 22nd level mage.

Any hatch or door the PCs touch grows a *magic mouth*, which chants, "*For the glory of the Firelord!*"

If the PCs go to a turret or viewing port, they will see an open cargo barge sailing away toward their own ship. The man whose image they saw stands aboard it, with a dozen other men in similar robes. A sitting man is spelljamming the barge—but a second, unoccupied helm is carefully being lowered onto the barge's deck by six of the men, who have obviously just carried it from somewhere.

The 'somewhere' is the ship that the PCs are now on. Their ship was sent into a dive by use of the helm, and the helm was then removed to the previously *invisible* barge by priests of the Firelord (the dozen high-level clerics), while the mage's

image was speaking to the PCs.

The mage, a 22nd level wizard, is also a servant of the Firelord, a god venerated on the world below. He and the clerics will either take possession of the PCs' ship or welcome the PCs aboard the shriekship and discuss possible trade business. They will fight if attacked, or if the PCs still aboard their own ship make any move to follow the rapidly-descending 'derelict' ship.

The weakest of the priests will remain aboard the barge. He will ram the PCs' ship if need be. He and the others will do anything to stop the PCs' ship from coming to the aid of the falling shriekship.

The helmless ship falls freely, uncontrolled, into the world's atmosphere. All aboard it are sacrifices to the Firelord, whom the clerics believe must be appeased in this way to allow them to safely continue spacefaring.

In one area of the ship they find a young girl—she looks to be about nine—who calmly sits on a cushion, waiting to die. She is Alathaera, a terrified 1st level mage chosen to be the world's sacrifice—as the PCs are to be the *spaceblood* sacrifice. If the PCs try to escape without her, she will scream and cry, begging for them to save her.

After a mile of free fall, the ship catches fire, blazing into a fiery crash in rocky high country, rather near the temple-city where the devotees of the Firelord are readying ships in which to explore space (i.e., the PCs' eventual escape from the world, if they survive).

Consult the SPELLJAMMER™ boxed set for the effects of fire and the crash-landing, and see "The Adventurer Who Fell To Earth" for the effects of falling on a character who falls or leaps out of the ship.

Those who survive planetfall can expect to find Thelorbin and a dozen low-level priests looking for them a day later to ascertain or make certain their deaths).

Out of Sight, Out of Mind

PCs in space sight a drifting, obviously-wrecked spaceship. Its side is torn open in a huge, gaping hole, twisted metal wreckage drifts along its sides, and what can be seen of the ship's interior through the hole seems dark and empty. The space-wreck is of a type they've never seen before, and it is HUGE.

Inside this space leviathan (see the "Ship Catalog") is a lurking hammer-ship. The giant space hulk has served this reaver ship as a base before, and retains a fouled atmosphere from earlier visits.

The hammership is a standard model (as given in the SPELLJAMMER™ boxed set rules), but its human crew are the mind-controlled slaves of six mind flayers.

The hammership's weapons are loaded and ready. The illithids will promptly attack PCs entering either the open end or the rent side of the hulk, forewarned by a mind flayer observer outside of the wreck.

The attacking mind flayers will try to disable and board the PCs' ship, using their *charmed* human slaves (treat as warriors of levels 1 to 5, 15 in number) to fight, and trying to *charm* the PCs when they get close enough. They are after the PCs as slaves and salvageable gear from the ship (helms and portable treasure).

The seventh mind flayer, the observer, is in an old porcupine ship (see "Ship Catalog") with a controlled human spelljammer aboard, pointing outward and looking like part of the huge wreck. If the PCs flee or defeat the hammership, the illithid will try to get to the PC ship and sneak aboard, hiding until he can revenge his comrades.

Fifteen Dead on a Warrior's Chest

The PCs, sailing in space, sight a tatter-sailed galleon as it glides out

from behind a nearby asteroid. The galleon fires a booming bombard at them as it draws close.

The boom was partially the shot, and partially the bombard blowing free of its mountings and flying off into the void (the weapon is cracked beyond any possible further use).

The galleon charges at the PCs, trying to ram and board. The galleon has been fitted with a piercing ram and the now defunct bombard. Otherwise it is as described in the SPELLJAMMER™ boxed set.

The reason for the pirate crew's reckless behavior becomes immediately apparent: they are undead. Swinging cutlasses and axes, the skeletons swarm aboard the PCs' ship. If the PCs avoid the ramming attack and the shearing attempt that follows if the ram fails, the skeletons hurl themselves from one ship to the other, not caring if they miss or are dashed to bone splinters.

The 42 skeletons have standard attacks and strength, yet they act intelligently—as though they can identify spellcasters and anticipate magic item attacks, moving to concentrate on such menaces!

The skeletons busily grapple the two ships together, or repeatedly ram until the ships become locked together, and fight tirelessly until one side is destroyed.

The skeletons are controlled by a higher intelligence, but the PCs will have to do some looking to find it. In the dark, empty galleon, surviving PCs will find only rooms strewn with blades and clothes, mouldering food, and unopened chests.

At the helm, however, bathed in an eerie greenish-white glow that seems to come from the helm itself, is a human female. Her eyes are closed, and she is slumped on one side, her face wet with moisture. A curved sword lies on the floor beside her.

She looks like a space gypsy, clad in a brightly-colored, puff-sleeved silk shirt trimmed with lace, a cummerbund, and breeches hacked off at

thigh level to expose her tanned legs—at least until they are hidden again by battered leather boots that come to well above her knees. At her waist is a sash, an empty scabbard dangling from it.

The lady, a 9th-level warrior (and former 6th-level thief), is named Tan-nansar Steelhair. She will not regain consciousness unless removed from the chair.

If the PCs move her, the chair seems to sigh and shrink back. Tan-nansar revives slowly, but if she is still in the helm chamber when she revives, she will scream at the sight of the chair, grab any weapon within reach, and attack the chair wildly, hacking at it again and again until she is restrained or collapses exhausted, leaving the chair covered with bright scratches.

Weak and terrified, she will be very grateful to the PCs, and will offer her sword in their service when she recovers. Her fate is up to the players. She is a rootless, wandering space gypsy, now bereft of home and friends (15 former crewmates all fell to the *ghost helm* before her).

The intelligence guiding the undead was the helm itself, which can *animate dead* (with a 90' range). Anyone sitting in it falls under its control and spelljams to its directions. It is a *lifejammer*, slowly draining the life-force from its helmsmen. The undead crew needed to capture living victims for it all the time.

The true nature of the *ghost helm*—and the means of destroying it—are left to the DM. If this encounter is properly handled, PCs will look twice at any strange helm before they sit on it, for a long time to come.

3. ANY PORT IN A SPACE STORM

This section consists of adventures involving floating space features (smaller than worlds) that spacefarers can use as bases.

Eye, Eye, Sore

Terrain: Wildspace (planetoid)
Total Party Levels: 120 (8 characters of 15th level average)
Total g.p. X.P.: 38,060
Monster X.P.:
Kill: 399,000
Defeat: 299,250
Retreat: 99,750 (less if some death tyrants entirely avoided)

Setup

Spacefaring PCs flee from or pursue a beholder ship into a certain crystal sphere. In the debris-littered wildspace within, they find several large, apparently uninhabited worlds (with usable atmospheres). Floating above one is a linked trio of planetoids, rotating slowly as one as they orbit. Light from a nearby star flashes off these rocks as they turn—the clear wink of light on metal . . . lots of metal!

The fleeing ship eludes the PCs, to return later, in another tale.

The Adventure

The PCs have found a beholder way-station. Of the three small planetoids orbiting in a cluster, two are littered with the debris of crashed ships of all types (intruders who were shot down; the DM can introduce new ships from this book). This forest of debris is studded with ready-loaded catapult and ballista emplacements. The weapons are aimed, fired and reloaded by *death tyrants* (undead beholders, see “New Monsters” section).

These zombie beholders are controlled by a *thagar* (also described in “New Monsters”), which has turned the way-station into a beholder death

trap. It is located on the largest planetoid. Approaching ships will be fired upon.

Randomly place normal catapults and ballistas on the moons’ surfaces so that enough can fire to challenge the PCs, but not to hand them inescapable doom. There should be at least one catapult and one ballista on each ‘side’ (90-degree arc) of a moon, plus one at each pole, another two on the out-facing sides of each moon, and an additional one on the inner sides. This means that at least three, often five, weapons per moon can reach a PC ship at any time.

These weapons are partly concealed by nets strung with panels and plates of wreckage. The weapons are paired together, enabling gunners to fire twice before reloading.

A single beholder can manipulate a ship weapon at its usual fire rate for a full crew. In some difficult circumstances, or if the gunner is undead or badly wounded, the DM may add a round to the time required for each reloading. Consider all weapons on the three moons to have enough ammo to be fired 20 times each.

The PCs encounter a total of 12 pairs of catapults and 16 pairs of ballistas, each with a death tyrant gunner. The only gunners on the third moon (site of the repair Dock) are two death tyrants who each control two ballistas, and the *thagar*, who controls no weapons directly.

The *thagar* controls the death tyrants as follows: all attacks are made in silence, without warning shots or sounds. Only those weapon sites within firing range of the PCs will fire and so reveal themselves. Others remain still and silent to avoid detection if possible.

Any intruder coming within range of the personal weapons (i.e., eye-stalk magic) of a death tyrant will be attacked by such means. The beholder gunners otherwise remain concealed and shielded as much as possible by the wreckage, sinking down motionless if necessary. (Note



that many of the death tyrants are missing eyestalks—select the powers a given death tyrant lacks, in order that PCs may be challenged but not massacred. Refer to the “New Monsters” section.)

The *thagar* has willpower enough to control *all* of the death tyrants simultaneously, and this magical link is too strong and enduring to be broken by any means short of slaying the *thagar*.

The third planetoid’s rocky surface is littered with damaged and rusting ship parts, piles of ballista bolts (1,190 in all), and large rocks (enough for 78 catapult loads).

Amid these piles are heaped, trampled weapons salvaged from many ships: 16 ballistas, 5 catapults, 8 jet-tisons, and 1 rusty piercing ram. Each will require some days of repair if they are to be mounted on a ship and made usable. Beings attempting to repair them will find the necessary tools and material in the depths of the Dock.

The Dock is a huge, slot-shaped pit carved from the rock of the planetoid. It is 100 feet deep, 70 feet wide and 200 feet long. Its bottom is littered with tools of all sorts, with beholder mouthpicks leaning against the walls,

and stacks of metal plates, spars, wooden ship ribs, and boards. Huge wooden ship-cradles line the bottom of the Dock. The sides and top are fitted with many cranes, anchor rings, and tether lines, so that ships can be suspended in a web-work of lines at any height. When the PCs arrive, the Dock is empty of ships.

The thagar lets the PCs approach, and then deluges them with gunnery, firing until the intruder is destroyed, sets down, or is out of range. If PCs do not retreat, the thagar floats down into the Dock, to the caverns connected to its depths.

If any PC enters the caverns, the thagar retreats into them further, defending itself and seeking to escape by another exit. At the same time, it will summon death tyrants, beginning with tyrants whose weapons have been disabled, and try to catch the intruders between them.

The thagar will leave only those death tyrants who are still in a position to fire upon the intruding ship, or who command a field of fire in the expected escape path of the PC ship. Whatever happens, the thagar tries to protect itself (even seizing the PCs' ship to escape strong, vengeful PCs, aided by all nearby death tyrants).

Unless seriously threatened, the thagar won't betray the existence of death tyrants who have not yet fired weapons—these lie in wait to blast a fleeing or incautious PC ship.

The storage caverns are all large enough for a beholder to float in and properly use its eye-magic. They contain many sharp bends where a beholder can lurk in cover, and have side-passages which loop back to form circles, so that the thagar can get behind its pursuers.

A lattice of special *force* spells devised long ago prevents cave-ins and collapses (and causes the cavern to radiate magic). Even deliberate damage to the walls will be unlikely to cause such disasters. The magic makes this 70% less likely than normal. It also reduces successful detec-

tion of spells or magical items by the same amount.

A "replacement" orbus also floats in a vast, lonely side-cavern behind massive barred gates (a minimum total Strength of at least 30 points is required to Bend Bars/Lift Gate).

The caverns also contain stored food (livestock and plants), the skeletons of chained humans (intended for lifejamming or food use), and a treasure cache.

The cache is in a cavern whose two entrances are each guarded by traps. Visible inside the treasure cavern are five ornate, high-backed, empty wooden seats with carved, fluted arms and backs, drawn up around a table.

Anyone who walks into the cavern will cause a floor collapse, spilling them and anyone within 10' down a 70' deep pit (7d6 damage).

Anyone trying to climb in (i.e., around an opened pit trap) by means of walls or ceiling will trigger a dead-fall of 11 rocks (each hitting at THACO 11 for 5d6 damage, and hitting beings in the pit at THACO 8).

The chairs in the cavern are *spelljamming helms*—a *lifejammer*, three *minor helms* and a *major helm*. None has any markings or differences of style that enable a PC to tell what they are. The inside back and seat of one chair (the *major helm*) is covered with old, black blood.

The table is a simple marble slab laid atop a stone box. Inside the hollow block under the tabletop is one more spelljamming power source: a *furnace* (see the SPELLJAMMER™ boxed set).

If the DM wishes to introduce other, less powerful magical items into the campaign, these could be found in a niche underneath the massive bulk of the table-block, to be discovered only if the table is dragged to one side. What magic items may be found here are up to the DM (possibly an *incense of meditation*, *Keoghtom's ointment*, and a *rod of resurrection*), if the PCs find this

encounter too deadly. Also consider placing a map or clues here leading the PCs into other adventures.

Visible to beings in the cavern is an open pit full of mixed coins, gems, and blackened bars (tarnished silver trade bars, worth 25 gp each, from the Sword Coast of the Forgotten Realms). The total value of the beholders' hoard is 38,060 gp, taken from victims, and held here for use in trade.

High up in the fissures of the cavern roof is a hidden *crown of the void* (see the "Personal & Ship Equipment" section), which constantly renews the atmosphere of this planetoid. To the diligent PCs who find it, this may prove the most valuable treasure here of all.

A PC who investigates any of the ship debris on the planetoid which holds the Dock will find a skeletal human pilot slumped in a shattered helm, clutching a rod in its crumbling hand.

The rod is a *rod of orbs* (see "Personal & Ship Equipment"). Its use may be crucial to the survival of a party too weak, unlucky, or foolish in its strategies when attacking.

The DM can draw attention to the *rod's* presence by having a wounded character fall or crawl into the wrecked ship where the skeletal spelljammer waits, or have the wrecked ship itself fall apart in the battle to reveal the skeleton. The *rod* has 64 charges when found. If victorious PCs decide to make the waystation their home, there is a daily 1 in 12 chance of 1-2 beholder ships arriving.

Hurricane Halvor's Real-Cheap Spacedock

PCs wandering in wildspace may find Hurricane Halvor, a dwarven armorer of note, and his mysterious traveling spacedock.

Halvor's Spacedock is simply a large asteroid littered with pieces

and hulks of wrecked and partially salvaged ships; a huge junk yard.

The mysterious thing about Halvor's place is that it seems to move from time to time, being found in a different sphere from the one it was in before. No one knows why it moves, and few know how. Halvor, of course, won't say. This lets a DM place the Spacedock in the PCs' way when needed or wanted!

The secret of Halvor's Spacedock is that a tunnel leading to the interior of the asteroid harbors a sarphardin nursery. There are always a dozen or so sarphardin lurking around (consult the "New Monsters" section). When they grow leery of an area, or when Halvor asks, they simply tow the asteroid somewhere else, aided by a hidden *major helm* crewed by the Shields (see below). The sarphardin defend the Spacedock against attack, as they are fond of Halvor, and not too thrilled with most of his customers.

Three *crowns of the void* have been stuffed into rock crevices around and deep within the asteroid, ensuring a rich, clean atmosphere.

Halvor himself leads an energetic and very well-armed (courtesy of much payment in magical weapons—choose whatever weapons seem suitable) band of six gnome ship repairmen. All are skilled armorers and carpenters.

The Spacedock charges outrageously high fees, but Halvor and his friends do good work, and most of their clients are in no position to balk at their deals. They fence stolen, seized, and salvaged goods, and can sell *helms*, *Locators*, *passage devices*, star charts, old ships and what-not to beleaguered PCs. The Arcane show up from time to time and demand that Halvor sell them certain items; he is wise enough to agree, and so they leave him alone.

If a captain can't afford Halvor's rates (ground repairs are cheaper and easier), but can't nurse it elsewhere for repairs, he can often swap

it for a crude, spaceworn old hulk that Halvor has fixed up.

Detailing just what can be found in or done with Halvor's mountains of junk would be an impossible task. Instead, decide what the Spacedock's facilities can and can't do on a case-by-case basis.

Used weapons of all sorts—all space weapons, and everything listed on the Weapons table under "Equipments (Lists)" in the AD&D® 2nd Edition *Player's Handbook*, are always available, for a few silver pieces over the normal 'new' price.

Halvor buys any chunks of ships or complete hulks towed into him, no questions asked, for half list price (less if badly damaged or missing a lot of weaponry and fittings).

Halvor's nickname is a joke: he works very slowly (though, for triple pay, he works like lightning; he once armor-plated a dromond in a day).

Halvor and his gnomes are all fighters; he is 7th level, LN (good tendencies) with 56 hp. They are all 5th level, LN, with 40 hp each.

Halvor protects his establishment with "the Shields," a hired adventurer band. They consist of a flesh golem, two heavily armored (in full suits of *plate armor +1*) and very visible 9th- and 10th-level fighters, and six quiet, half-elven thief/mages, who sneak about and strike when not expected.

Halvor's wife is a 7th-level human cleric of Ptah, Thaerea, who leads worship and aids all on the Spacedock with her healing powers. Ptah meant all to travel the universe as he did, opening doors they might find and seeking knowledge that lies behind them. What better way to aid all travellers, than to repair their ships and replenish their supplies?

The only thing in short supply on Spacedock is food. Halvor's band have enough for themselves, and provide (at *very* high prices) emergency rations for space voyagers, but they have little to spare. Unless you like mushrooms, that is. Two of the gnomes farm mushrooms on the

walls of all the interior passages and caverns (except the Watcher nursery).

PCs can encounter the Spacedock again and again, until Halvor becomes an old and mistrusted friend (he never takes credit). Here are some goings-on connected with the Spacedock that can make for adventure during a visit:

- Void scavvers attack. Not one or two, but in groups of five to seven. They cruise in regularly, attacking anyone and everything in their usual way, and run the Shields (and Halvor) ragged fighting them. One of the gnomes is happy—he's always wanted to try scavver-steaks with mushrooms, but everyone else might agree to pay to have the attacks stopped (the sarphardin are too busy defending their young to tow the Spacedock).

The attacks are coming, of course, from our old friend the mind flayer (see "Too Big To Throw Back" in the preceding section), who plans to ride in on a scavver, take control of the two fighters, and use their brawn and his powers to control everyone else.

He'll then be able to plunder the Spacedock of everything useful (including these handy slaves), perhaps even coercing the sarphardin into towing it back to his world for him. If any ships show up for repair while he's assuming command, why, they're just more loot to be had.

Of course, it's up to the PCs to foil this grand plan. The mind flayer doesn't know that they're on the Spacedock—and if they've run into him before, this could be a juicy rematch. After he's finished rolling his eyes, burbling "Why me?," and shaking his head, he'll have a score to settle with them.

- Some of the mushrooms planted in the Spacedock begin to grow dramatically, revealing them to be spores of the various harmful fungi types (see the AD&D® *Monstrous Compendium* under "Fungus," or devise new types). They begin by at-

tacking the sarphardin nursery. The alarmed sarphardin hustle their young out and leave (for now). The Shields and PCs must face hundreds of fungi. Mushrooms, anyone?

Adventure Ideas

Here are some adventure ideas for a DM to develop. Tailor the strengths and types of monsters and treasure in all of these 'mini-adventures' to the individual campaign.

Giants Jump Up

PCs entering a new region of space unwittingly pass too near a world dominated by evil giants.

From a tiny moon, fire giants bound up into orbit to attack intruders. Each giant carries enough air to stay for 2-20 rounds, and brings throwing rocks, a long line tied to its waist to allow it to 'climb' back to the moon, and a second, shorter line with a grapnel hook, for snagging ships, drifting beings, and so on. Rules covering the use of lines in space are given in this book's "New Rules" section.

A Castle Floating in the Stars

In the flow or the deepest reaches of wildspace, the PCs see a huge, floating castle. It is built of dark stone, with Gothic towers and arched windows. Flickering colored lights flash in the windows. Those who peer in can see mages studying dusty libraries full of books (*illusions*).

The whole thing is, of course, a trap for adventurers. Adventurers lured into the castle pass into a gigantic *anti-magic shell* covering the entire place, a *permanent* magic put in place by the castle's owner.

The high-level mage who built the castle is quite deranged from a long and lonely existence in space. Once a collector of butterflies, he now col-

lects anything that happens by, *wizard locking* all doors and windows behind any beings who enter (the windows are all protected by *glassteel* spells, and the doors are all of lead, steel, and stone layers encased in wood).

The PCs will be able to hear this *invisible*, crazed, 27th-level wizard humming and singing to himself (nonsense songs and nursery rhymes) as he wanders, but will never be able to see, touch, or attack him, no matter what they do.

The wizard, *Staetulee*, (and hence the castle is his, *ahem*, 'staetulee home') is harmless. If adventurers break a wizard lock or smash a way out through a wall, he will come humming along to restore things, neither attacking nor stopping them.

The castle also has two more actively dangerous inhabitants. A slithering tracker glides around the castle, scavenging. It cleans up the messes left by a giant bulette (it has 15 Hit Dice, but is otherwise normal), who hunts intruders.

Knowing that most intruders cannot escape, the bulette chases them around the labyrinthine castle for sport, leaving them alone at times, and then charging into wherever they've taken refuge. It never attacks its master, *Staetulee*, nor any of his 'pets' (the tracker and any PCs whom the unseen *Staetulee* suddenly pats on the head, crooning, "*Nice! Oh, very nice!*" to—if they attack or grab him, he will be gone. Later behavior will not affect 'pet' status).

If the DM has an old castle floor plan from a played-out module or the floor plan of any large home (even a modern one), it can be used for the castle. Several plans, jammed together will do, for the castle is full of short stairs, rising and falling corridors, galleries that bridge and look down on other rooms, dead-end halls, and so on.

Just to cap things off, a pack of nine spaceworms happens to be resting on the underside of the castle

when the PCs happen by. Six will attack anyone on the PCs' ship (or anything edible on or in the ship itself, eating through hatchways to get in), and three will wait to attack anyone emerging from the castle.

Treasure Island

PCs come upon a small crystal sphere full of debris, dust clouds, and the like. Here they find a bare rock littered with space wreckage: the asteroid base of a pirate who never made it home.

There's an upright, junked caravel, with no masts or helm, and a huge hole in the hull. The bones of the dead lie everywhere. Some crew are now undead: 6 zombies and 14 skeletons wander the rock, attacking intruders.

There are several caves on the rock. One is a deadly trap (DM's choice). Another leads to a false floor that drops intruders into a pit of ochre jelly.

Another cave holds a junked but salvageable *lifejammer helm* and a gnomish do-nothing (noisily!) impressive machine. Here too is a wild-eyed unfortunate wight named Vengunn, the lost captain's faithful mate. She howls for her vanished love as she attacks: "*Jonkidd! Jonkidd! What's become of my Jonkidd? Where've ye hidden him?*"

If Vengunn is turned or near defeat, she flees down a winding tunnel that leads to a treasure cache of four rotting chests full of 1,000 gp each. These will fall apart when shifted. Also here is an intact, dusty, ship's furnace.

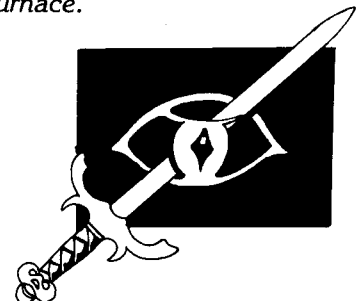

FLOTSAM OF SPACE



This section of *Lost Ships* is a grab-bag of interesting space phenomena to dress up the space in which PCs travel. Use these entries to enliven long, dull voyages, add color and realism to play, and to make simple encounters into greater challenges for strong PC parties by beefing up the monster ranks, or provide an exotic setting to wage combat (a space dogfight, for example, can be far more hair-raising if held amid tumbling asteroids!).

A DM can devise flotsam encounter tables if desired, but deliberately choosing specific encounters to introduce into an adventure usually makes for more interesting play.

Daveys

"Daveys" are drifting spacefarers found in space, either dead or in suspended animation. This is a human term of unknown origin.

Elves and dwarves usually refer to

such hapless individuals as "drifters," but this term can cause confusion: it's also the space-wide salvage term for a disabled vessel, drifting in space without power.

Slaving races in space usually refer to such creatures as "meat."

DMs may use Daveys to provide PCs with minor treasure (coins, potions, spell scrolls, or maps). More rarely, a drifting ex-adventurer can provide PCs with a spellbook or magic item—or death, in the form of spaceworms (see "New Monsters"), disease, or other infestations. Or PCs may be in need of reinforcements—or enemies.

Just about any NPC in the DM's repertoire (deceased PCs with name changes, NPCs whom the characters left groundside or characters taken from used or unused AD&D® adventure modules) can become a Davey.

Custom fit the Davey character to the spacefaring setting of the SPELLJAMMER™ adventures. Give

him or her skills and personal possessions that would suit a spacefarer (consider the proficiencies in the "New Rules" section). Don't go overboard (pardon the pun) with possessions. Consider what someone might reasonably be carrying when the situation occurred that caused them to become a drifter. Decide *why* this character became a Davey. What could have happened to set this character adrift (alive or dead) in vastness of space? Did a fearsome accident occur? Was this being encased in magical *softwood* by doomed allies in hopes that his life might be preserved? Has it become undead? Is he the sole survivor of a band of adventurers (as was the case with the archlich Sharangar Szeltune in the earlier adventure "I Must Go Up to the Stars Again")? Is the Davey "trapped," possibly a host for a horrible space monster that lies dormant waiting for a new, living host?

If a Davey is still alive, give serious



The Sea of Shadows

This infamous sargasso lies near Krynnspace. It is an irregular region of swirling purple mists, studded with red radiances that grow, pulse, and die away again, apparently at random.

Some sages believe that the Sea is the result of some titanic, ancient space-battle or magical disaster. Others fear it has been deliberately created by some fell power seeking to engulf all of space.

The Sea has not been observed to grow or move about. Neither, however, does it dwindle or disappear. It is home to seemingly endless numbers of undead shadows, who attack all who venture near.



thought to the motivations he or she (or it) may have. Chances are that the being will want to resolve events from his or her former life. Adventures, even campaigns, can be built around the history and motivation of just one significant, well-thought-out NPC.

Debris Fields

Contact with a debris field of sufficient mass causes a spelljamming ship to slow to 'normal' movement. A spelljammer will be able to 'feel' the field as the ship slows, but will not be able to detect other ships within or beyond it, due to the large amount of movement of debris fragments.

The SPELLJAMMER™ boxed set Combat rules describe the damage of piloting a ship through a randomly tumbling debris field caused by a war long ago or a natural cataclysm.

There is, however, another sort of debris field, sometimes called a "rubble field." This is a field deliberately laid in space as a defense for bases or disabled ships. Raiders sometimes arrange fields to provide cover, using magic, chain-linkages, even captured power sources to move rocks as missiles.

A ship slowing down to cautiously work its way around or through such a field may suddenly be rammed (as if by a ship with a blunt ram) by a large asteroid that unexpectedly lunges at them.

Determine hull and personnel damage according to the situation. A rough guideline for determining such damage follows. Extrapolate damage for a given rock from this example: A *large* asteroid (a ton or more in weight) will cause at least 2d8 hull points of damage and a 50% chance of a "Ship Shaken" Critical Hit if it strikes a ship with a direct hit. A glancing hit from the same size of asteroid, where it skips along the deck or rigging, menaces all crew in that area (attack rolls on each, 3d8

dmg to all hit), has a 50% chance of doing 1d4 hull points of damage.

Less hostile, natural sorts of debris fields may harbor strange types of spacefaring monsters (ones that don't breathe—undead and void scavvers especially seem to haunt such places).

PCs may well find small treasures (such as dropped swords, messages in bottles, and individual coins or gems) floating in the field. The wise DM uses such goodies as arrows pointing to future adventures as often as possible.

Space is limitless, and with a good ship one can go in just about any direction—so why not give PCs the urge to go in every direction, all the time?

If PCs start to slow down and comb every debris field they come across, the DM can always bring on lurking monsters. . . after all, who better to encourage tales of treasure (and leave trails of gold floating in the void) than slavers?

Dust Clouds

Here and there in wildspace lie little-known 'dark regions,' feared by some spacefarers because they afford concealment to pirates and monsters of the void (like the ever-present scavvers).

Entering such a cloud slows a spelljamming ship to 'normal' speed and immediately fouls a ship's air envelope. Sometimes (21% chance) mold spores, krajen spores, gas spore rhizomes, or other harmful substances are floating among the cloud, and even more often one or more sizeable rocks tumble around in them. Blindly-faring ships will almost certainly collide with such rocks (see Debris Fields, above, for a damage example).

Light spells and magical item effects used within a dust cloud will cause the entire cloud to light up, perhaps attracting the attention of

nearby ships. To the crew of a ship inside the cloud, however, visibility is increased only by 60' to 110' (1d6 + 5 x 10 feet), depending on the thickness of the dust, as the dust all around glows in a blinding, swirling maelstrom.

Fog-creating and other moisture-related spells cannot replenish (freshen) a ship's air while in a dust cloud. If they are cast inside a cloud, mud globules will fill the air, halving the time that the already-fouled air will last before becoming deadly.

Additional applications of such spells will reverse this condition if cast *after* the ship leaves the dust cloud, but the ship will be covered with slippery mud. If any spores lurk amid the dust, such extra moisture will cause them to grow and react, presenting the crew with a new danger.

Flame Rings

Rings of flame float here and there in wildspace. Some are large enough to provide illumination for entire spheres; others are too small to even plunge a ship through their centers.

These magnificent natural rings are planar rifts that leak atmospheric gases from other planes into the void. Some are short-lived, others seemingly eternal. Not all betray their presence with flames—at least until the PCs blunder into them.

Some are poisonous gas plumes. Treat them as deadly air, as *confusion*-causing vapors (effects lasting 2d6 turns), or as Contact Poisons of types K, L, or M: c.f. "Combat (Poison)" as described in the *Dungeon Master's Guide*.

The gases of other rings can replenish a fouled atmosphere. They are breathable, but may have side-effects on crew such as light-headedness, drowsiness, or occasional *confusion*. They may also harm glowmoss and other shipboard plants, or cause unprecedented growth or mutation of such plants.

Still other rings give off intensely flammable gases. They first appear as nonflaming areas of swirling, translucent gases in space: an apparently clear and empty area of space through which the stars and other objects beyond look blurred. If one stares hard at such an area, an impression of roiling movement will be gained, but one will still not see anything definitely menacing. An odd smell may be present, but it may not be one familiar to the PCs, and hence may give no clue as to the gas's nature and potential danger.

Once ignited, these rifts become eternal flame rings, the gases always burning around the edges of the rift (PCs who do this with a flame or spark will find themselves in the center of a *fireball*, typically of 16d6 damage intensity).

Gnomes and giff have been known to try to bottle such flammable gases in glass flasks, for use as incendiary weapons. Some ships even return from such expeditions . . .

Dwarves and other veteran spacefarers collecting glowmoss know that the heat and light given off by many rings causes glowmoss to grow thickly on nearby asteroids, rocky debris, or large planetoids.

Some flame rings are surrounded by floating gardens, ready for harvesting and re-harvesting. Of course, raiders soon learn of such popular ship-stops, and may lurk nearby, typically using camouflaging clumps of air-producing glowmoss to conceal their ship drifting amid rocks to await prey.

Ships plunging through the center of flame rings are almost always torn apart. Their cargo and crew may or may not survive to reach another plane of existence, which may or may not support life. The DM is encouraged to make this route to other planes an always-risky 'last ditch' way out of certain death to an unknown fate (and destination).

Survivors may find themselves disarmed, disabled, and stripped of

vital equipment (like weapons) in a hostile, harmful plane unfamiliar to them (*Manual of the Planes AD&D*® rulebook can provide suitably exotic locales).

Floating Islands

In wildspace, traveling spacefarers sometimes come across clumps of entangled plant life, ranging in size from horse-sized balls up to clumps as large as mid-sized asteroids.

These typically have a rock or piece of ship debris (perhaps even a helm!) at their core, around which generations upon generations of spaceborne plants have grown, clustered and intertwined. Larger islands have been found sprouting trees or sporting small ponds.

Hungry ghouls, monster zombies, serpentine medusae, and even giant insects have been reported on the larger floating islands. Sometimes the plants themselves are carnivores.

Many adventurers drifting and lost in space, or fugitives abandoned by their fellows, have reached or been marooned on floating islands—condemned to breathe the air the plants produce, eat boring or even sickening vegetation, and drink plant sap—perhaps forever.

Adventurers on the run, or overloaded with nearly-dead colleagues breathing precious shipboard air, or in need of a refuge would do well to remember these often-overlooked little oases.

Flow Beacons

In the everchanging rainbow mists of the phlogiston, spacefarers occasionally come across floating, spindle-shaped metal 'stars' which glow with periodically-blinking patches of phosphorescence and emit a constant singing sound. Each star sings in a different pitch.

Most sages and space captains believe them to be magical buoys



Many intrepid spacefarers have tried to explore the foglike interior of the Sea in hopes of finding treasures. Most have died there, as their helms ceased to function and they drifted on helplessly into the Sea's depths with dwindling air. Some have used mechanical propulsion to probe the Sea's edges, or scudded dangerously close along its perimeter, flinging nets or grapples within to try to snag unseen wrecks and draw them forth. Fewer still have been successful, dragging forth all manner of strange ships, creatures, and treasures.

What attracts explorers is the presence of the Arcane, who frequent the area, often calmly hailing passing ships while drifting in the void, sitting on helms or other items they are willing to trade for passage and gold. More often, Arcane are seen riding sarphardin near the Sea. Many adventurers believe that an Arcane base, source of power, or storage cache is hidden within the Sea, though no one has yet learned the truth of this.



marking routes through phlogiston, for they never seem to move in the flow, holding their positions even more steadily than the spheres.

But who placed these marker buoys in space, and where they mark the way to, is unknown—lost now amid the mists of passing time.

No known weapon, including ship ramming, can move or harm a beacon or cause it to react in any way. Flow beacons reflect *all* spells cast on them back upon the caster, and never stop or alter their singing.

The legendary spacefarer Grimbeard Holast, a dwarf who made several fortunes running precious cargoes through the void over many years, went to his deathbed claiming that he saw The Spelljammer sweep past a beacon in the flow one day, and the buoy lit up with racing streams of flashing lights as the ship passed, quieting again when the mighty ship of space had disappeared. Elminster (among others) believes him, but certainly The Spelljammer has been seen far from known buoys, and seems to go about ignoring them entirely.

Khelben Blackstaff and his mysterious colleague Grimwald have remarked that they have often seen Arcane near flow beacons, and venture the hypothesis that the 'beacons' are actually Arcane ships, probes, or supply caches. Arcane seem not to hear or understand queries about the mysterious, ancient buoys.

Veteran spacefarers warn, however, that far less mysterious ships—pirate ships and slavers—have been known to use the buoys themselves as rallying-points and landmarks. "*Heed, they say, and fly thy ship accordingly . . .*"

Gas Clouds

These strange gas mixtures drift in wildspace and outer reaches of planetary atmospheres. They may or may

not be clearly visible. Some are transparent. Most are translucent (sort of misty), colored purple, green, amber, or yellow.

Their gases can be highly flammable or poisonous (see Flame Rings for effects), perfectly breathable and atmosphere-replenishing, or produce unpredictable side-effects in those breathing them.

These side-effects have been known to include the following (the DM is encouraged to develop his or her own new effects): *confusion*, *fear*, or *feble-mindedness*, lasting 2d6 rounds; breathers are *enlarged*, *petrified*, made *invisible* or *diminished* for 1d8 turns; breathers forget all spells, command words, and truenames or summoning names currently memorized; breathers involuntarily turn gaseous (attaining *wraithform*, this condition lasting 1d12 rounds regardless of character attempts to end it, and then ending abruptly); breathers suffer 1d4 internal damage, and cough flames or small arcs of lightning for 1 round (1 point of damage to those struck, range 5'—plus effects on flammables or phlogiston, if present); all curses (including lycanthropy and mummy rot) and diseases that a being is carrying or is infected with are instantly cured, damage and all; injured characters are *healed* and spontaneously *regenerate*, and so on. Note that any or all of these conditions could affect different members of the same crew at the same time.

The DM can use any random method of determining what effects occur. In all cases, PCs should be unable to anticipate what a given cloud will do, unless they have passed through it before within the same day. Note that natural spell-like powers may be as affected as character magic, and that monsters will suffer strange gas-cloud effects as well as PCs.

Ice Fists

A recurring peril of space travel is bombardment by ice fists flying at high speeds. These concretions of frozen water seem to be most common in the colder spheres of wildspace, but may be encountered anywhere.

Collision with an ice fist of sufficient size can result in a "Ship Shaken" Critical Hit and up to 2d6 hull points of damage. These ice balls usually shatter on impact, driving spear-like ice slivers everywhere, which endanger crew (typically, all crew on deck or in the rigging must face three attack rolls, hits doing them 2d4 piercing damage each).

Contact with ice fists (particularly if a ship can avoid any form of violent collision) can be beneficial. Ice fists can release trapped fresh air and replenish supplies of drinking water.

Unfortunately, one out of every eight ice fists contain gases such as methane, which are flammable or harmful, fouling the ship's atmosphere.

Ice fists can be formed in many ways. Sometimes such balls are formed of the waste-water of a ship, jettisoned before reaching port. Rare ice fists may contain a frozen monster or even treasure—but these are more common in spacebar tales than in real life.

Though many ice fists float forever in space, drifting slowly or trapped amid debris fields, most are met hurtling in a hurry.

Planetoids

This term refers to worldlets or chunks of rock in space which are large enough to hide a ship behind or land a ship upon, particularly if smaller asteroids orbit them.

Planetoids are often roughly spherical, but can be of any shape. They are found in wildspace, alone or orbiting a world or star.

Almost all planetoids have atmospheres. The few that do not are oddities. That atmosphere, however, may be composed of almost anything. For possible strange atmosphere effects, see the entry for Gas Clouds, above. Breathable atmospheres are occasionally fouled, having given up much of their good air to passing ships.

Planetoids become garbage dumps and crash sites as more ships sail the nearby stars. A planetoid is 70% likely to sport some sort of space flotsam, corpse, or wreckage, and 45% likely to be inhabited by some form of life (90% if it has a breathable atmosphere). Most such life is glowmoss, starshine, and other plants, but everything from spacegoing dragons to rats who abandoned a disintegrating spaceship have been encountered.

Planetoids are also known as hiding-places for treasure, messages, and hostages. A planetoid is 10% likely to have something of the sort about it (half that chance or less if in a very heavily-traveled area).

It is recommended that a DM detail six or seven planetoids before spacefaring play begins, and use them as needed (PC activity will probably require at least two planetoid visits before three weeks of spacefaring game time have elapsed).

Sargassos

Although the inhabitants of some worlds use this term to mean a graveyard for sea-going ships, in space it refers to a specific and very deadly menace to spaceships.

Certain areas of wildspace, for unknown reasons, are 'magic-dead.' Spells cast within or into these areas will not function and will be lost, magic items and artifacts entering them flicker and fail, 'losing power' until removed from the area, and magical travel or scrying across or

into such areas is impossible.

Some of these areas are clearly visible as different from their surroundings, such as the *Sea of Shadows*, but most are invisible—deadly menaces into which spacefarers may readily blunder.

A spelljamming individual can 'feel' a sargasso when near, as a yawning, sickening emptiness. Too near, usually. A spelljamming ship can pass within feet of the unseen boundaries of a sargasso without harm. A ship that touches or crosses those boundaries, however, may be doomed forever.

Contact with a sargasso gives a spelljamming individual a sickening, gut-wrenching feeling, as if some . . . thing is sucking at him. No hit point loss occurs.

Spelljamming and all other magical power sources fade to half-speed in a single round, cease on the next round, and come back to half-speed on the third round.

On the fourth round, such a power source will regain normal operation if out of the sargasso, or fail completely if still in contact with it. The helm or other engine cannot be restarted while the ship is still in the magic-dead area, and the ship usually drifts slowly on, until it either exits the sargasso or strikes something that alters or stops its progress.

By this time, the crew may be long dead from lack of air. *Softwood* and *contingency* spells or other protections will not function until the ship is free of the sargasso.

When their helm suddenly fades, experienced spelljammers strain everything to swing their ship around or reverse its path by looping sharply up or down. Those unfamiliar with sargassos usually do nothing until it is too late—the steering change must be made before the third round 'pulse' of final power.

Allow NPC spelljammers and those PC spelljammers whose players do not take action an Intelligence Check and a Dexterity Check. If both



Diseases

If complicated diseases or Infestations are not wanted in play, they can be handled thus: A cloud of spiny, greenish-white spores wafts around PCs. Each must save against Breath Weapon or fall writhing, dropping held items.

Affected victims are unconscious for 2-5 turns, lose 1 hp, and operate at half strength for 1-2 days. Their skins erupt in blackish sores (temporary 3-point Charisma penalty), and they are hard of hearing and dazed, attacking last in any combat round.

The DM may add to player uncertainty by making characters perform Ability Checks for fairly simple actions now and then, and describing feelings of sudden heat or cold, sweating, and spreading sores. It is suggested that nothing else harmful occur.

If a disease is being simulated, simply leave out the collapse and spore cloud.



succeed, the spelljammer instinctively did the right things, and the ship will immediately or shortly escape the sargasso.

If only one succeeds, the ship may be turned to a course that will let it escape from the sargasso just before death comes, or something else may occur, as the DM desires (such as a collision with an atmosphere-rich wreck within the sargasso).

Spaceworms

These diminutive dangers are detailed in this book's "New Monsters" section. They may be encountered anywhere in space, seeming to avoid only surfaces already thickly grown with flow barnacles (another new monster).

Desperate spacefarers claim that spaceworms are adequate eating, tasting like greasy, lumpy white sausages. If cooked, they dissolve into slime and wrinkled, salmon-like skin—so they must be eaten raw. Giff and illithids have been seen eating them, but there has been no demand for them to appear on spacebar menus, even in giff space.

Elminster tells of eating lightly fried spaceworms, but states "*they are food for folk who don't care to think where their food has come from or what it's been doing.*"

Space Missiles

This term refers to powered, fast-moving ships, weapons, and artificial space debris flying wild and free through space. These can cause crashes if they run into other ships—the effects of which are detailed as a "Critical Hit" under Combat, in the SPELLJAMMER™ boxed set.

A chief cause of such encounters are errant *furnaces* or *artifurnaces* which have torn loose from a broken-up ship while still operating. These are usually uncontrolled, shooting blindly through space at the speed

and direction imparted by their breakoff.

Spore Fields

Many spore clouds float in space. Some appear as dust clouds, while others, such as "drifts" of krajen spores (the monstrous Krajen is found in the SPELLJAMMER™ boxed set), are made up of spores too small to be seen unless a crew is specifically *looking* for them.

Some spores are relatively harmless. They may carry the miniature forerunners of glowmoss or other edible (such as "moonmint," a parsley-like garnish that grows on planetoids near fire worlds) or harmless plants (such as the ferns known as "spacefronds," which grow in asteroid belts everywhere).

Other spores are more deadly. They may carry space spore rhizomes (a variation of the gas spore), spores that will become other monstrous fungi (see "Fungus" in *Monstrous Compendium*) and other things that grow rapidly in the lungs (for simplicity, handle these as ingestive Poisons).

This danger has led to the term 'disease field,' applied to several known semipermanent spore fields (marked on star charts—one of the most valuable warnings thereon!).

The DM may develop specific diseases if desired (note that mummy rot and lycanthropy are properly curses, not diseases, and cannot be contracted from spores).

Other spores, such as krajen, are harmful to a ship or its cargo—including food, air, and water, even if not directly harmful to the crew.

The DM is encouraged to develop these latter menaces—the search for antidotes can suddenly make a boring space jaunt into something urgent and exciting!

ANGELSHIP

One Square = 5 Feet

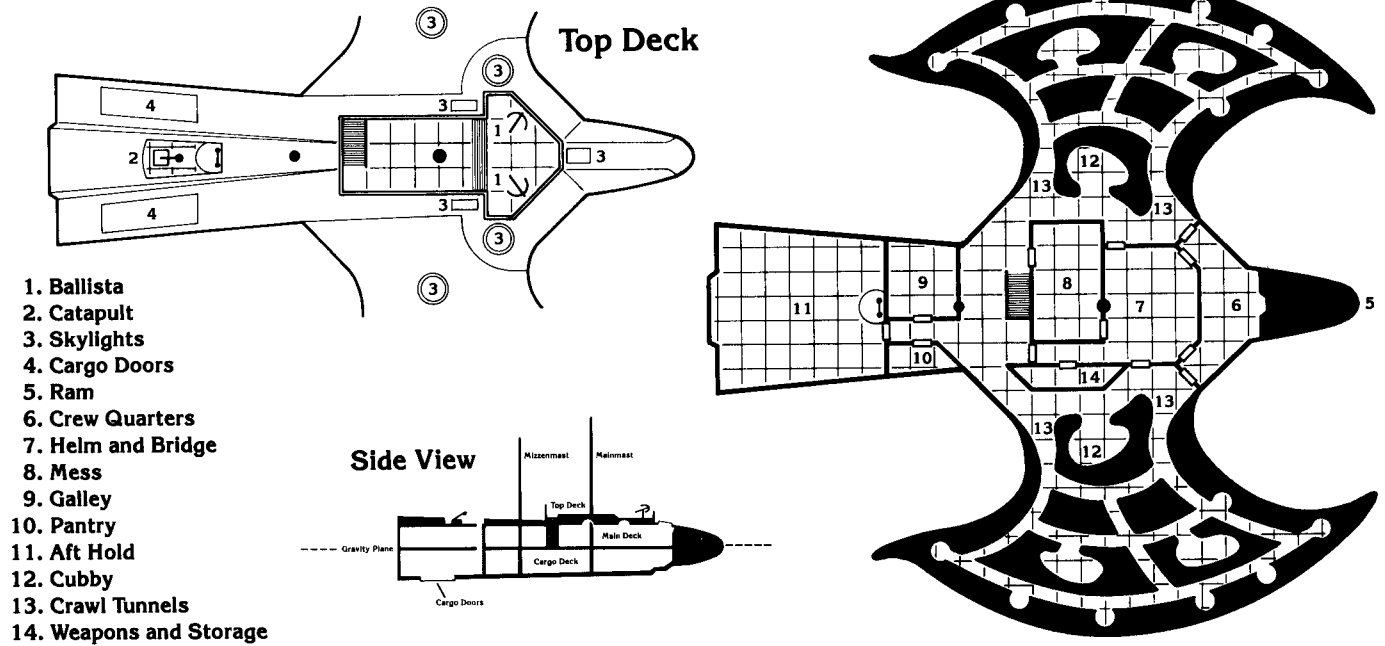

The ships featured in this book are detailed here for reference. Personalize ship appearances and the variant armaments to confound those dastardly players unable to resist reading these entries!

ANGELSHIP

Built By: Kobolds
Use Primarily By: Kobolds
Tonnage: 33 tons
Hull Points: 33
Crew: 8/33
Maneuver Class: C
Landing—Land: Yes
Landing—Water: No
Armor Rating: 6
Saves As: Thick wood
Power Type: Minor helm
Ship's Rating: As helmsman
Standard Armament:
 2 Medium ballistas Crew: 2 each
 1 Medium catapult (aft)
 Blunt ram

Cargo: 21 tons
Keel Length: 130'
Beam Length: 135'

Rarely seen nowadays, these basic, but versatile ships were the backbone of the kobold space presence until they were all but wiped from the void by the elven armada. Outmaneuvered, outgunned and outnumbered, most angelships were destroyed.

Named for a kobold legend of winged humans who *healed* fallen warriors (dubbed 'angels' by human tale-spinners), these ships have distinctive flaring wings, making them well-suited for movement in planetary atmospheres (i.e., taking off and landing on worlds).

Crew

The crew sizes given are for humans. For kobolds and other S-sized creatures, the minimum crew is 12, and the maximum is 66.

An angelship's helm and command chamber (bridge) lie where the wings join the hull. Crew quarters are located forward, in the ship's bow between the bridge and the ram. The galley, mess, and other chambers lie aft, before the cargo holds. Some are stripped to a single, huge cargo hold nearly filling the entire length.

Most shipboard kobolds sleep in 'cubbys' in the wings, reached by a web-work of crawl-tunnels filling the wings, also used to repair the wings and for gunnery. A kobold ship taking off from a world usually does so with all hatches open, to force fresh air into these tunnels.

Ship Uses

Trading: Its ability to easily take off and land on worlds makes the angelship ideal for its main use in the hands of both kobolds and later owners: a hardworking, utilitarian trader. Angelships preceded the trader of today as the most popular, versatile

merchant vessel in space, and are widely regarded as the greatest kobold spaceship design (though some question exists whether kobolds could have actually designed it). The angelships that survived the Great Hunt still fly today as much-patched traders, displaying a wide variety of weaponry and outfitting. Experienced space captains are wary of angelships. One never knows what race or weaponry one is facing: *anything is possible*.

Bulk Cargo Carrying: Many have seen service both before and after the Great Hunt, as stripped-down, utilitarian cargo ships. Removing most weaponry, the crew quarters, and hollowing out the interior as described above resulted in a creaking but spaceworthy bulk carrier with up to 26 tons of cargo space.

Some angelships still see service in such roles—and the crashed wrecks of more litter planetoids, abandoned bases, the sargassos and asteroid belts.

Naval Fleet: The angelship is too small to see much practical use in the space navies of today.

To the few kobolds still in space, however, converted angelships formed the backbone of their navies. Painted flat black, they were cloaked with magical *darkness* and *invisibility* spells raised by circles of kobold shamans. The kobolds also used a now-lost *darklight* spell, which allowed full vision within the created darkness to beings touching the caster during casting. These enchanted craft were known as *night angels*.

A night angel was heavily armed, its cargo space reduced to a mere seven tons. Usually plated with metal and slate, a night angel bristled with ballistas, and had two piercing rams mounted on the leading edges of its wings (a dismal failure; the wing usually gave way before the rammed ship did!). A few crashed night angel wrecks have been repaired and refitted, often by pirates. Still, there are persistent rumors of kobold night an-

gels lurking far from the known spheres, flitting about in the flow, striking at those who blunder into their new territories.

BARGE OF PTAH

("Battle Barge")

Built By:	Humans
Used Primarily By:	Humans
Tonnage:	60 tons
Hull Points:	60
Crew:	24/60
Maneuver Class:	F
Landing—Land:	No
Landing—Water:	Yes
Armor Rating:	8
Saves As:	Thin wood
Power Type:	Major helm
Ship's Rating:	As helmsman
Standard Armament:	
6 Medium ballistas	Crew: 2 each
4 Medium catapults	Crew: 3 each
2 Medium jettisons	Crew: 3 each
Piercing ram	
Cargo:	40 tons
Keel Length:	145'
Beam Length:	60'

Built to defend early spacefaring humans against orc, ogre, kobold and goblin attacks, these barges were home to the faithful of Ptah. Some few still fulfill that function today. Slow and clumsy in battle, they were often deathtraps for their crews, giving little protection from enemy fire. Many riddled barges still drift in the flow.

Crew

The minimum crew for a Barge of Ptah reflects its size, difficulty of handling, large array of weaponry, and labyrinthine network of interior rooms. Traditionally captained by the highest-ranking cleric of Ptah aboard, the crew is divided into three or six shifts, each commanded by a cleric of 8th to 12th level.

The Great Chamber of the temple, at its heart and top (surmounted only

by the Dome of Stars) is the traditional location of the seated captain and the charts and devices of the navigators (also high-level priests). The *spelljammer helm* itself is concealed at the rear of the base of the Dome of Stars, behind a false wall. It is reached by a stairway whose bottom comes out by the captain's chair. The stairway is always guarded, and a spare spelljamming mage always sits near the captain, ready to take over should a disaster occur. A second, backup *major helm* is located in a secret chamber beneath the Great Chamber, reachable only by means of a hatch beside the captain's chair.

Ship Uses

Templeship: The clergy of Ptah built their barges to have ornate, mobile temples in space, in which to live and take offerings from the spacefaring faithful.

Templeships were rich in treasure, taken as offerings and in payment for light ship repairs and healing. For the latter, templeships were famous across space—the refuge of many a stricken spacecrew, fleeing from battles that had gone against them.

The riches to be found on templeships and the clerical policy of refuge to all (and *from* all—no shipboard fighting or arms to be borne except by the priests of Ptah) made the templeships the frequent targets of raiders. As the temples slowly grew into labyrinthine cities, they began to harbor the less-than-savory; murderers, thieves, undercover slavers and fences of stolen goods—with even priests taking up the latter profession.

The armaments of such ships were steadily improved to deal with threats—the few that survive today, still serving their original owners, are virtual floating fortresses.

A typical templeship has 12 human wizards and 48 warriors, all staunchly loyal to Ptah and his priests, serving as guardians, spell-

jammers, and crew. Commanding them and leading the temple's spiritual life will be 10-60 priests of all levels (including a "High Opener" of not less than 14th level, and usually of 16-18th level).

Such large templeships are always fitted with *major helms* and expanded with outriggers fore and aft and an increased superstructure until they approach the *major helm's* 100-ton limit. This, plus magical devices to increase and purify the air supply (see this book's "Personal & Ship Equipment" section)—which the clergy always seek to buy, devise, or take as offerings, increases the air supply to support such a large crew and visitors.

Templeships regularly purge and renew their air by dropping into planetary atmospheres, and use *retain air*

envelope spells while in space to avoid losing valuable air to visiting ships.

Battle Barge: Some observers have reported seeing seized barges in orbit around orc- and ogre-dominated worlds, stripped of the spired temple walls and domes of Ptah, and bristling with batteries of catapults and ballistas. At least one has been fitted with a stolen spell reflector (see Gnomoi Gear in "Personal & Ship Equipment").

Such "battle barges" are designed to ward off unwanted intruders, maintaining a stable orbit and moving only to engage in battle. *Death helms* and caged slaves are kept aboard for propulsion. Crew is often kept to a minimum, allowing for long tours of duty. The ready-loaded weaponry are fitted with cables so

that a single gunner can aim and fire several weapons from a distance.

Quite often, shuttle-craft are kept ready to rush air and extra crew up to a minimum-crewed, orbiting battle-barge should a spaceborne enemy craft approach.

Cargo Raft: Salvaged battle barges see service in some reaches of known space as bulk cargo carriers. Stripped of all superstructure and weaponry, the decks of these vast rafts are dominated by tether lines and grapple-bars used to lash down cargo. A slender fin rises amidships, surrounded by water casks and food bins for the crew. Sleep-hammocks hang along its sides while the *major helm* that propels the ship sits atop it like a throne. Service in such spartan, utterly- unprotected vessels is not popular, and is often

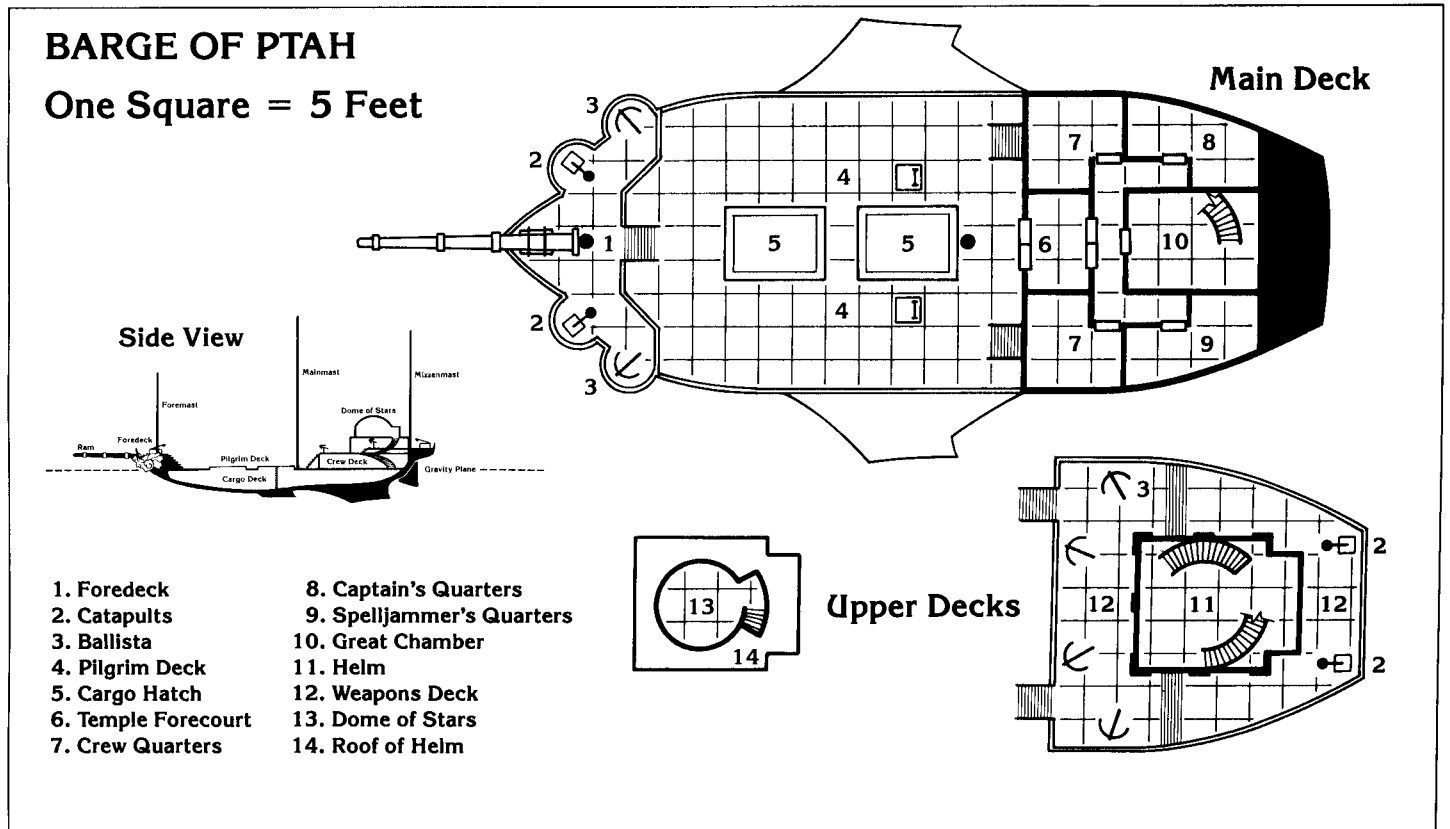



Scalykind Employers

Spacegoing lizard men often hire human mages to spelljam their bloatfly broodships. These are wizards of 16th level or more, whose duties include spelljamming, casting *glassteel* spells to repair the broodship's complex egg-piping, and piloting an egg-shuttle home (their relief, the next hired mage, arrives in it when taking over piloting of the bloatfly).

Such mages receive 70,000-90,000 gp per stint, plus a magical item and a new spell (whatever the lizard men can seize, find, or buy). Most are loners who bring only an abbreviated spellbook with them. Research (in a sequestered area far from the precious piping) is encouraged within limits of shipboard supplies.

No scalykind treachery against a mage is known—they need the wizards too much (until their own magic masters *glassteel* spells).



temporarily compelled upon unfortunate wizards as a sentence for murder or other major crimes. Though in dangerous areas (i.e., most of space), such unarmed rafts are always escorted by well-armed ships.

Some cargo rafts are fitted with improvised under-edge jettisons, or with 2-8 Greek fire mines stored around the rafts' edges. A favorite human free trader trick is to hide a ballista, catapult, or even a wreck-boat armed with such gear on the raft's deck, under piled cargo. When an attack occurs, the raft's crew run about looking helpless and lost. If the attacker gets too close, the ship's weapons are suddenly revealed in an all-or-nothing counterattack.

More than one reaver crew has used a cargo raft fitted with harpoon guns to strike kindori space whales and receive a tow through space from the pain-wracked beasts. Harpoon guns are simply ballistas that fire modified bolts tied to lines.

Death Barges: Undead are known to crew a few Barges of Ptah. Sometimes the crews, who cruise about looking for living of all races to destroy, are the remains of clergy of Ptah, and other times they are raiders who seized a barge during or after a battle. Often such darkened templeships appear as drifting derelicts—until spacefarers board them to look for treasure, and are attacked by suddenly-swarming, silent undead.

BLOATFLY

Built By:	Lizard men
Used Primarily By:	Lizard men
Tonnage:	48 tons
Hull Points:	48
Crew:	6/40
Maneuver Class:	E
Landing—Land:	No
Landing—Water:	No
Armor Rating:	6
Saves As:	Metal
Power Type:	Furnace (15%)

Ship's Rating:	Minor helm (85%) 2 (furnace) or as helmsman
-----------------------	--

Standard Armament:	36 Medium ballistas (in pairs) Crew: 2 each
Cargo:	6 tons*
Keel Length:	155'
Beam Length:	55'

* Does not include 36 tons of egg-tubes.

These vessels are found only in close orbits around fire worlds (warm suns). Built by the advanced-intellect lizard men of space as egg incubators, they warm the eggs' new generations of lizard men so that the hatchlings will be brighter and stronger.

Bloatfly ships represent the present pinnacle of scalykind ship design. Their metal construction incorporates all the advanced gear that the lizard men can devise, steal, or purchase. The black bloatflies have a distinctive spindle shape, tapering at nose and tail, and studded with 18 bumps or blisters (each is a special type of turret, containing a double ballista mount.). Two sets of skeletal wings or outriggers protrude from the flanks of a bloatfly, one amidships, the other just aft of it.

Crew

The bare-minimum crew needed to operate a Bloatfly in space is six, but over a dozen guards are customarily added to that number to operate the ship's weapons and internal incubator systems. The ship's major use requires a margin of eight tons of air, so a maximum of 40 crewmen may be taken aboard.

The crew consist of lizard man guards, all equal in rank, over whom are a shaman, typically of 5th level, who functions as shipboard physician and spiritual leader, and a war leader (captain), typically a fighter of

BLOATFLY

One Square = 5 Feet

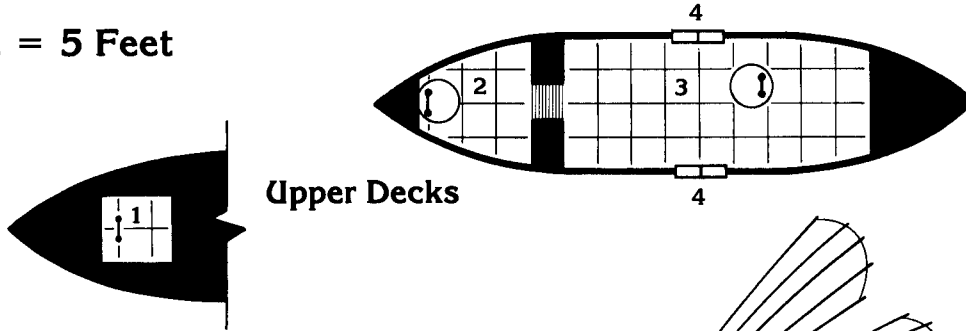

- 1. Helm
- 2. Bridge
- 3. Cargo Hold
- 4. Cargo Doors
- 5. Armory
- 6. Crew Quarters
- 7. Mess
- 8. Cargo
- 9. Storage
- 10. Outside Access
- 11. Swim Tubes
- 12. Double Ballista Blisters
- 13. Nutrient Storage
- 14. Platform Over Incubation Tank
- 15. Incubation Tank
- 16. Nutrient Pumps

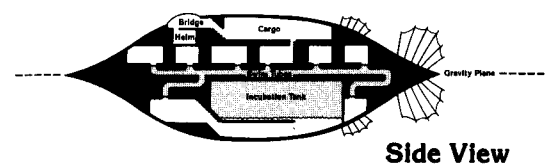
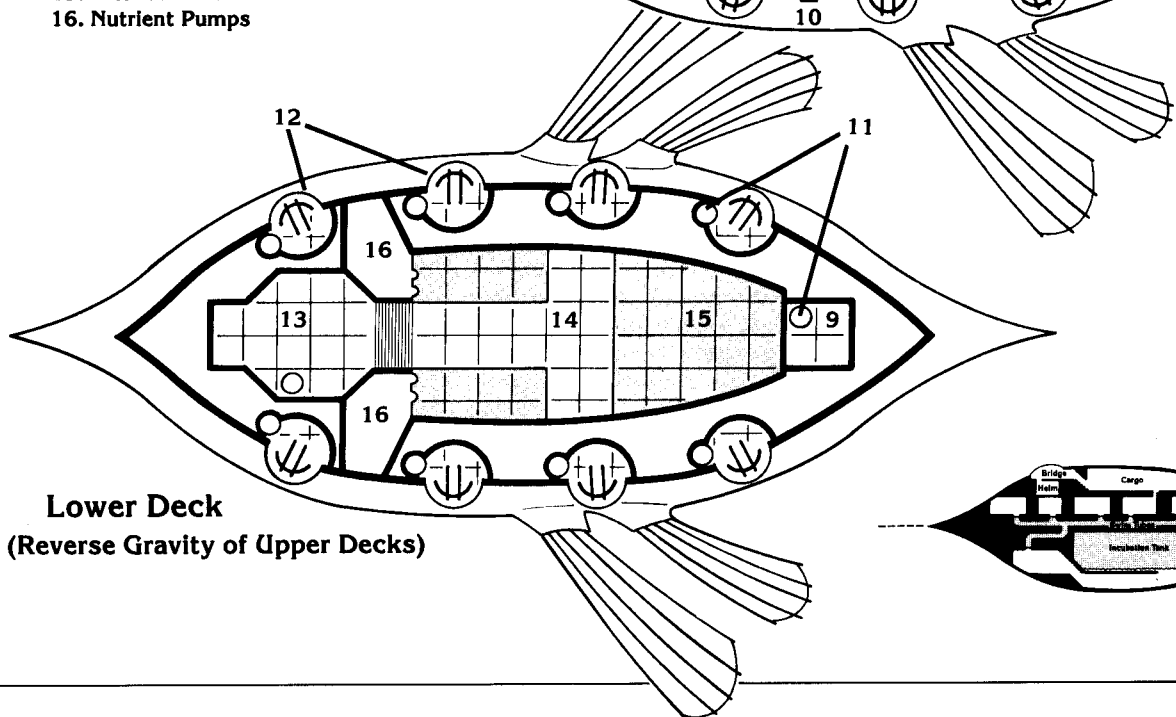
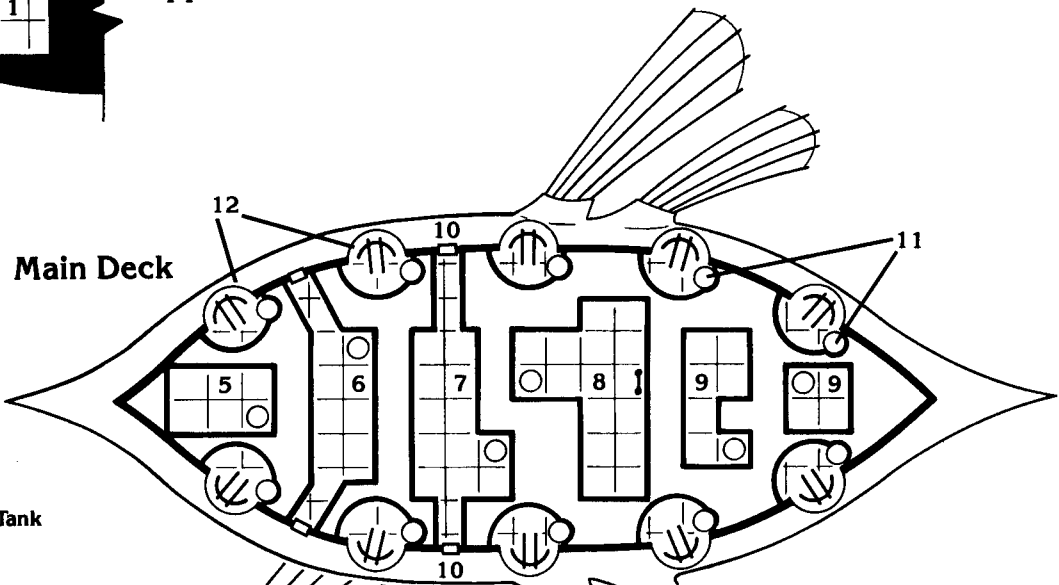



Slaver Gear

On cargo barges and other converted slaver ships, slaves must be confined with makeshift aids: coffles, portable iron cages, and so on. Such conditions make it slightly easier for slaves to escape. Makeshift conditions leave slaves more hopeful that freedom is attainable and more likely to try to escape.

Such attempts are dangerous to slavers and always result in damage to, or the death of, some slaves.

Illithid slavers deal mostly in humans, the most versatile, disunited, and numerous spacefaring race. Humans are also the least predictable and most troublesome of slaves, so the cruel mind flayers have developed several items of slaver gear.



at least 8th level. Bloatflies are sometimes fitted with *furnaces*, but are usually spelljammed by hired human mages, using *minor helms* purchased from the Arcane. The *spelljammer helm* is located deep in the body of the ship, in a chamber below the bridge (which is directly below the *glassteel* treated observation bubble atop the hull).

Ship Uses

Broodship: Bloatflies have been seen operating only as egg-incubating broodships, stationed in fixed orbits around stars. Their coating of black tar retains the maximum heat from the sun (for effects of contact with this matte-black coating, refer to the adventure "Slither Around The Sun" in this book). Gas spore minefields protect many broodships.

A broodship's interior is almost entirely filled with a labyrinthine network of transparent glass piping (reinforced by *glassteel* spells), punctuated by small chambers where the guards store their food, weaponry, the needed plants and spores for altering the chemical balance of the water, and larger swim-tunnels linking the rooms with the weapons blisters and the observation bubble. The ship will be hot and very damp, like a steam room, with an atmosphere that's thick with the choking odor of smouldering tar from the ships's skin.

Eggs are nurtured in nutrients pumped through the tubes by means of manually powered paddles. Plants crammed into all unused cavities in the ship provide a constantly-renewed atmosphere for both crew and eggs. The guards repair or expand the piping as necessary, and defend the ship furiously against all non-lizard men who approach it.

The ballistas are loaded and tight-winded, ready to fire at all times. Each of the blisters on the ship's exterior conceals two swivel-mounted

ballistas, loaded and fired by one lizard man and turned and aimed by another, using stout pulley-and-rope arrangements and an array of wooden pull-handles.

Inside each circular hull access hatch are three glass grenades full of space (gas) spore rhizomes, which the lizard men hurl at anyone trying to enter. Also waiting by each hatch is a rack of six cocked and loaded hand crossbows.

Other Configurations

Some spacefarers report the existence of scalykind (lizard man) colonization ships, which are simply bloatfly hulls emptied of piping and crammed full of food, plants, and lizard men of all ages and both sexes. Such ships are typically unarmed, and escorted by armed wasp vessels (described in the SPELLJAMMER™ boxed set rulebooks).

These are said to be growing more numerous as lizard men explore more boldly into the flow and find new spheres. Once they colonize a world, the ship is sent into a close orbit around the world's sun and converted into a broodship.

Lizard men are close-mouthed about these ships, and utterly unwilling to sell, trade, or build them for other races.

Even so, some bloatflies have been seized by human and giff pirates and used as mobile bases or repair ships, hidden away in remote spheres. At least one has been modified to serve as a guardian ship for a pirate world, and absolutely bristles with heavy weapons.

Others have been damaged and thrown out of orbit by attacks or disasters, and may be found crashed on planetoids near warm suns or drifting empty in asteroid belts.

CARGO BARGE

Built By:	Humans
Used Primarily By:	Humans, Dwarves, Mind flayers
Tonnage:	25 tons
Hull Points:	25
Crew:	None
Maneuver Class:	F (see below)
Landing—Land:	No
Landing—Water:	Yes
Armor Rating:	8
Saves As:	Thick wood
Power Type:	None* Minor helm as backup (15%)
Ship's Rating:	None or as for helmsman
Standard Armament:	None
Cargo:	20 tons
Keel Length:	40'
Beam Length:	20'

* 100% of mind flayer craft are fitted with *series helms*.

These unglamorous, usually battered spacecraft are simple boats dominated by massive hitching-bollards for towing, and in some cases by high, removable side walls used to make carried cargo more secure.

Towed cargo barges decrease the Maneuver Class (MC) of a towing craft to their own MC. Even if *series helms* are used on the barges, the tonnage of towed cargo barges is added to the towing ship, to determine whether the *helm(s)* involved can move the added load.

Crew

None, although common practice is to assign one crewman of the towing ship to each barge in tow, allowing the crew to keep a watch on the lashings and security of cargo.

Ship Uses

Towed Cargo Hauler: Barges are almost always used in space voyaging to bring extra air and cargo. A small vessel whose owner gets a *major helm* from a purchase or adventure and wants to use that excess hauling power will often tow a cargo barge. They can be towed empty, carrying only air and food to extend the length and range of exploratory voyages.

A war-vessel wanting to haul extra cargo can always tow a cargo barge, which can be cut loose if needed to restore the warship's full Maneuver Class in battle. A cargo barge can even be deliberately cut loose and used as an obstacle or ram, to bring about a "Crash" result on an enemy.

In the early days of human space-faring, these popular vessels were purchased or seized by dwarves and

DEATHGLORY

One Square = 5 Feet

1. Catapult
2. Ballista
3. Captain's Cabin
4. Strongroom
5. Guest Cabin
6. Water Gun
7. Crew Quarters
8. Helm
9. Jettison
10. Weapons Spar with Tangle Guns
11. Cargo Hold
12. Mess
13. Galley
14. Storage
15. Armory/Storage
16. Lab/Workshop

Fore Deck

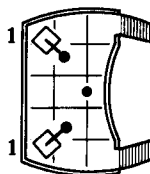

Flying Deck



Aft Deck

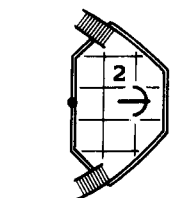
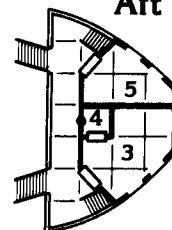

Upper Aft Deck

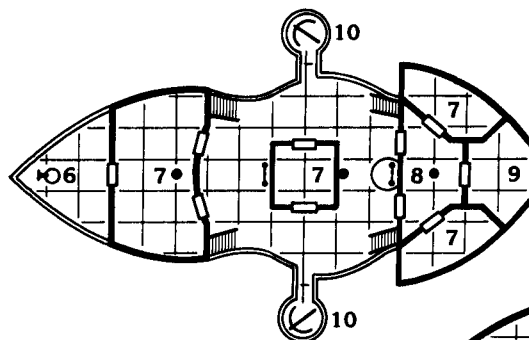

Top Deck

Side View

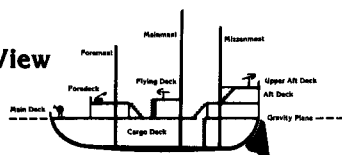

Cargo Deck
(Reverse Gravity From
Upper Decks)

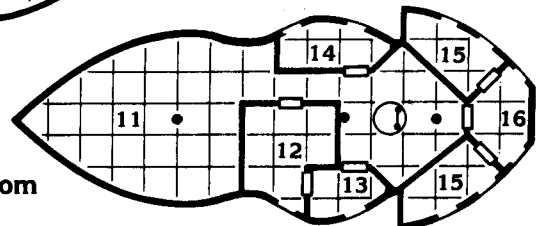



These include the isolation tank (simply a hollow iron sphere equipped with interior manacles, air-holes, and a stout locking door), stun-collars (locked iron throat-collars connected by switched wires to an on-deck mechanical static electricity generator, which is charged slowly by the movement of the ship), and hand-held goads.

Goads are hooked clubs. Goads do 1d6 damage (1d3 vs. L-sized creatures), and can be used to trip or ensnare an opponent within 6 feet. Such an attempt does 1 hp of damage, and uses the same attack roll. A successful attack is an automatic trip or hook; a hooked being is allowed a Dexterity check at the end of each round of holding to slip free. A hooked being suffers a 4-point Armor Class penalty.



illithids for their own use—the first time a human ship design had met with an enthusiastic reception by other races in space.

Slave Boat: Only mind flayer slavers still use cargo barges widely. The barges are fitted with either barred cells, deck manacles (limb and neck collars chained to deck-rings), or both. Where cells are absent, the manacles are often attached to long wooden beams bolted into place on the deck. These ‘coffles’ can be detached at the beginning and end of the voyage without freeing the slaves individually. A line of slaves carries its own ‘beam’ and does not waste valuable crew time (and limits individual escape opportunities).

Illithid craft can carry as many as 200 slaves (though a limit of 180 ensures more slaves survive long voyages). Crowded slave-barges require all their air and cannot lend any to the towing ship.

Illithid slave boats are fitted with *series helms* and linked in space with long cables. Each whip and goad-armed mind flayer crew includes at least two helmsmen, who power the helm of their barge in shifts. Linked slave barge chains may be quite long, and are usually guarded by nautiloids or other mind flayer warships. Service on a slave boat is not popular with mind flayers; they offer little or no shelter from hated light. Their frustrations are usually vented on the unfortunate cargo.

Shuttle Tugs: Some cargo barges are fitted with backup *minor helms*. This allows them to be used as escape craft if a towing ship meets with disaster (allowing intrepid PCs who discover one on a world to get into space). It further lets them maneuver around tight spots like bases or asteroid belts to avoid collisions.

When precise navigation is not crucial, such as moving cargo between a world and an orbiting spaceship, helmed cargo barges are used as shuttles, or even as tugs towing several other cargo barges.

Power Rams: A recent neogi development, this variant is a frightening weapon. Power rams are captured barges that are fitted with *helms*, prow rams, and wreckboats.

A neogi pilot simply directs the barge into a collision course with a ship, or other target, then escapes in the wreckboat. Some are equipped with weapons to defend themselves during approach or to increase the damage they can do. Others are loaded with loose rubble, increasing their impact damage.

Ram attacks are detailed in the *Concordance of Arcane Space*, under “Crashes.” Consider a hull point of damage to equal 10 hit points of creature damage, dealt to all creatures within a 20’-radius impact area, a successful Dexterity Check allowing half damage.

A ram’s impact affects structures as if it was a “screw or drill” siege attack (page 76 of the *Dungeon Master’s Guide*). A crash-landing ram forces all structures within a 40’ radius to save twice. Two successful saves means a structure is unscathed, one save means a structure is damaged (walls cracked, roof breaches cause leaks, objects fall or are hurled about), and failing both saves means a direct hit, heavy damage, and a probable collapse into rubble.

The *spelljammer helm* aboard a striking power ram must also save twice to avoid destruction. A single successful save results in the helm being shot off at great speed into the air, onto a voyage of its own until it crashes into something (becoming a small ram itself or a space missile, as detailed in the “Flotsam of Space” section).

Other ships protect power rams during their approaches, which are mostly against ground targets (mobile targets can usually elude such clumsy attacks). The most frightening thing about power rams is that the neogi seem to have *spelljammer helms* to throw away in this fashion.

EEL SHIP

One Square = 5 Feet

Side View

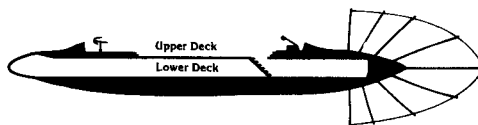

1. View Ports
2. Ballista
3. Catapult
4. Helm
5. Captain's Quarters
6. Spelljammer's Quarters
7. Crew Quarters
8. Galley
9. Pantry
10. Cargo Hold

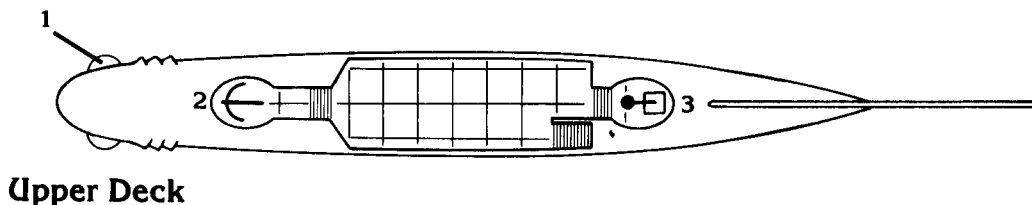

Upper Deck

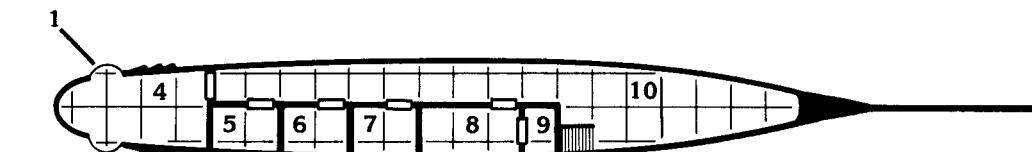

Lower Deck

DEATHGLORY

Built By: Gnomes
Used Primarily By: Gnomes
Tonnage: 70 tons
Hull Points: 70
Crew: 18/70
Maneuver Class: D
Landing—Land: No
Landing—Water: Maybe (leaks badly!)
Armor Rating: 6
Saves As: Metal
Power Type: "Gnomish" Major helm
Ship's Rating: As helmsman, minus 1 (due to spell reflector)

Standard Armament:

2 Medium ballistas Crew: 4 each
 2 Medium catapults (forward) Crew: 6 each
 1 Medium jettison (rear) Crew: 3
 2 Tangle line guns Crew: 4 each
 2 Water cannon Crew: 3 each
Cargo: 35 tons

Keel Length: 80'
Beam Length: 55' (outriggers to 85')

This gnomish dreadnever-class ship actually *works!* These top-heavy vessels are ruggedly overbuilt, and equipped with the best gnomish weapons and technology.

A deathglory has outrigger weapon spars jutting from its sides: protrusions ending in weapon batteries reached by covered metal crawl tunnels. Weapons located here command larger fields of fire.

Crew

The crew sizes given are for humans; for gnomes, they are 26/140. Recent deathglory successes have bolstered gnome morale, creating gung-ho crews who work together with speed, dedication—and *uncommon common sense!* Some gnome captains have hired human wizards to helm their deathglories. Experienced gnome gunners and spacers

CARGO BARGE

One Square = 5 Feet

1. Hitching Bollards
2. Crew Hut
3. Cable & Chain Lockers
4. Cargo Deck
5. Removable Side Walls

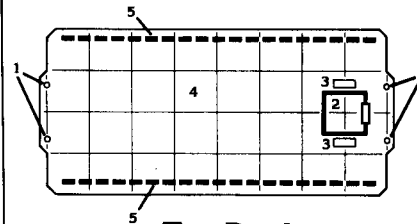

Top Deck



Side View



The Sargasso of the Seven Stars

This famous magic-dead area lies in a sphere strategically located in heavily-traveled space. Ringed with seven silvery fire worlds of distinctive beauty (more than one space-ballad refers to "the light of the seven stars"), it is a void littered with debris. Near its center floats the gigantic, impressive hulk of a space leviathan.

Little is known of the leviathan at the heart of the sargasso, although red (signal?) lights appear on it, blinking from time to time. It drifts, apparently unpowered, but is largely intact and thought to be inhabited.

Many curious explorers have ventured toward the distant, visible wreck to be trapped forever when their power sources failed in the invisible, deadly sargasso. Scavvers have been known to feast on such hapless explorers.



known as 'trusties' command four to seven (usually six) crewmen each.

Ship Uses

Battleship: The armament of these craft announces their war-might to all who meet them. Their gear includes spark darts, glass globes, ballista-fired supersweepers, tangle line guns, water cannons, and spell reflectors (see "Personal & Ship Equipment" under Gnomoi Gear). The glass globes hold greek fire, puddings, jellies, and oozes.

Metal and ceramic plating (which keeps falling off!) graces the hulls of every deathglory. Many have shields to conceal and protect weapons not in use: a heavy, ungainly gnome merchant clipper may suddenly be revealed as a mighty deathglory!

Deathglories are kept busy escorting gnomish merchant ships through dangerous areas, pirate hunting along favorite trade routes, and exploring into the flow in search of new worlds for gnomes to settle! These vessels have become the backbone of the gnome navies, guarding the richest, most populous gnome worlds and territories.

Other Configurations

Rumors tell of a trouble-plagued version bristling with rams and jettisons. Spies confirm experiments with captured *series helms* and plans for a long-range flow galley using a deathglory hull.

EEL SHIP

Built By:	(early humans? Insectoid race?)
Used Primarily By:	Humans
Tonnage:	20 tons
Hull Points:	20
Crew:	4/20
Maneuver Class:	C
Landing—Land:	No
Landing—Water:	Yes
Armor Rating:	6

Saves As:	Thin wood
Power Type:	Major or Minor helm (15% still fitted with Furnaces)
Ship's Rating:	2 (Furnace) or as helmsman

Standard Armament:	
1 Medium ballista	Crew: 2
1 Medium catapult	Crew: 3
Cargo:	8 tons
Keel Length:	110'
Beam Length:	15'

An earlier, cruder version of the lamprey-ship, these slim vessels are popular for planetary defense. Many are used by pirate raiders unable to get anything better, or to conduct stealthy hit and run damage missions for hire.

Crew

The usual fighting crew of this type of vessel is 10 to 12, although the ship can sail with as few as four. The *spelljammer helm* is located just forward of amidships. The captain and navigator sit behind the helm, forward of the crew section. A ladder in front of the helm leads up to the ballista turret, and a ladder in the crew section leads up to the catapult.

Ship Uses

Raider: The origin of this small, dangerous-looking ship is unknown. A persistent legend says that they were used by an insectoid race, precursors of the thri-keen or a highly intelligent race of giant wasps. Sages often point to the crawl-tunnel running down the center of the ship to the tail, too small for a human to stand in. Others believe this to be an early human ship design, possibly a case of sacrificing crew comfort for ship strength and looks.

Nevertheless, humans soon took to building these ships. When *spelljamming helms* began to replace the early *furnaces*, they became even more attractive. Primarily short

PYRAMID SHIP

One Square = 5 Feet

- 1. Galley
- 2. Mess
- 3. Workshop
- 4. Armory
- 5. Stores
- 6. Captain's Quarters
- 7. Spelljammer's Quarters
- 8. Crew Quarters
- 9. To Cargo Deck
- 10. Bridge
- 11. To Helm
- 12. Cargo Doors
- 13. To Lower Deck
- 14. To Main Weapons Deck
- 15. Helm
- 16. To Bridge
- 17. To Upper Weapons Deck
- 18. To Cargo Deck
- 19. Weapons Hatch
- 20. To Main Weapons Deck
- 21. To Observation Deck
- 22. To Upper Weapons Deck
- 23. To Helm (optional)
- 24. Observation Hatch
- 25. To Observation Deck

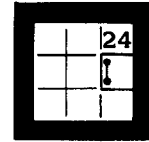
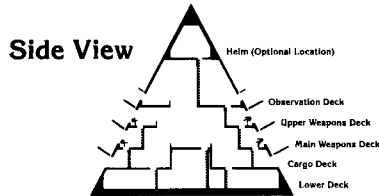

Helm (Optional Location)

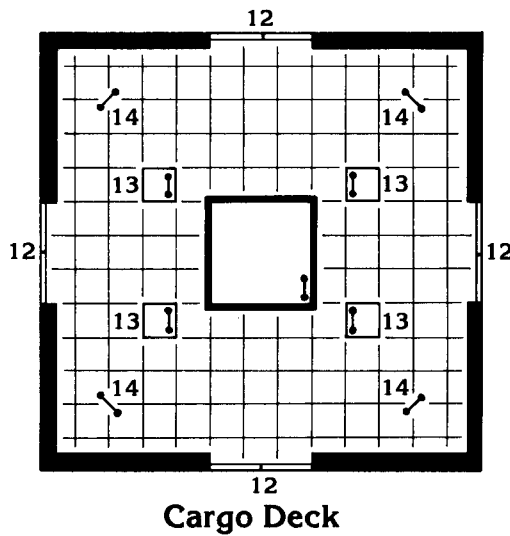

Cargo Deck

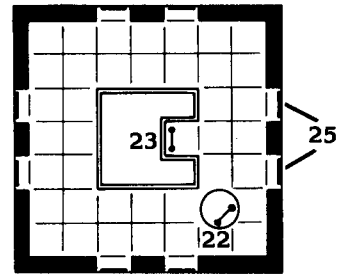

Observation Deck

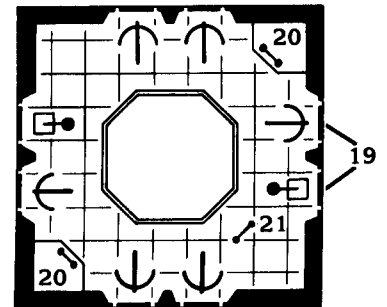

Upper Weapons Deck

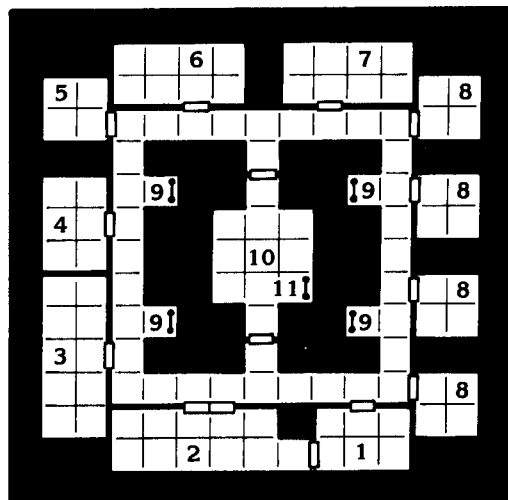

Lower Deck

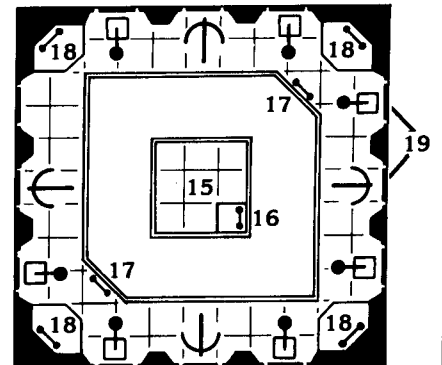

Main Weapons Deck

range combat craft, they were used as escorts against the goblin in the early days of human spacefaring, and as the ships of pirates and other reavers.

Such raiders often refit an eel ship with heavier weapons. They often use a trick that gains a one-shot weapon without the cost of actually installing one. The aft hatch is unlatched, and held shut by long pull-rods. A long, debris filled cargo dolly fills the tail-tunnel. By releasing the pull-rods and violently shoving the dolly aft until it jams against wheel stops, the equivalent of a single heavy jettison load fires back out of the ship (3-18 hp damage, fills map hex directly behind the ship with debris, has no firing velocity to reach other hexes).

This use makes the eel ship's tail leak badly, so that ships that must land on water are usually run straight onto a beach to prevent severe flooding damage or sinking.

Defender: A more lawful use of eel ships is as short range escorts and planetary defense ships. Such ships are customarily refitted with 2 heavy ballistas (one added far aft) and a heavy catapult. The cargo space disappears (only one quarter ton remains for food and water storage). The crew increases to 15 (a crew of 19 ensures faster weapon loading and provides a spare helmsman).

Some 30% of eel defenders are fitted with a Greek fire projector aft, instead of a second ballista.

FLYING PYRAMID

Built By:	? (Human followers of Ptah?)
Used Primarily By:	Undead humans
Tonnage:	90 tons
Hull Points:	90
Crew:	6/90
Maneuver Class:	F
Landing—Land:	Maybe (crash 60% likely)
Landing—Water:	No

Armor Rating:	1
Saves As:	Stone
Power Type:	Death helm or Furnace (90% have both; 10% lack a Furnace)
Ship's Rating:	2 (Furnace) or as for victim
Standard Armament:	
10 Heavy ballistas	Crew: 4 each
10 Heavy jettisons	Crew: 4 each
Cargo:	26 tons
Keel Length:	80'
Beam Length:	80'

A favorite spacebar tale is the ship-raiding of the Dark Pharaoh, an undead mummy of unusual powers who preys upon all spacefarers to gain additional undead servitors. The Pharaoh is said to plan a kingdom of undeath in the stars and seeks to bring new ships under his sway.

The Dark Pharaoh is interested in acquiring priests of Set to serve him as agents in the worlds (sending more slaves and treasure to the *Son of Set In Space*), and always hopes to capture such priests when he attacks passing ships.

So much is believable—but where listeners begin to scoff is when they are told of the flying pyramid that sails the stars as the Pharaoh's ship. A pyramid of stones? Aye, indeed! It'd soon be a drift of stony rubble, falling apart around him!

Wiser spacefarers speak of more than one pyramid spaceship: ancient vessels of Ptah-worshippers, perhaps, or templeships of other Egyptian gods whose influence has waned until they have been forgotten in space. They do exist, and have been found as planetary defense craft in human-dominated spheres, as undead crewed raiders or drifting derelicts, and even as dwarven shuttles, traveling from a worked-out dwarven citadel ship to an asteroid selected as their new ship.

Crew

Crew sizes given are for M-sized air-breathing creatures. Undead can be crammed into a pyramid, though a practical maximum crew is 360.

To fully man a typical pyramid's weapons, a total of 80 crewmen is needed (a crew of 42 is sufficient to man six of each weapon type).

Ship Uses

Piracy: Most flying pyramids rove space as raiders, either undead preying upon all living things, or pirates (particularly humans) who use the unlikely appearance of their vessel to surprise passing ships.

A flying pyramid may have two of each sort of weapon per side and underneath (or only one weapon per side and two of each type underneath). These weapons are concealed behind stone hatches. This, and the decrepit, irregular appearance of most pyramids, contributes to surprise (the DM should describe the lurking pyramid amid planetoids and other space features to see if players identify it as a ship before it attacks).

Flying pyramids are *very* old, constantly crumbling and shedding their outermost layers of stone blocks. Stony sides are often cracked, pitted, and scarred. Wise pyramid captains encourage surface growths of glow-moss and other spaceborne plants to better hold the stone blocks together. Undead usually lack the intellect to care for the appearance of their ship. Large pyramids may even have debris from crashed flitters, lifeboats, and other space vessels adorning their flanks.

Undead crewing a pyramid often cannibalize the insides of their vessel to load catapults and jettisons, until the craft ultimately collapses into a field of debris. Weapons may be salvaged from among such a field of stones, as may stone blocks as space cargo—but salvagers should beware of the undead who also float in the debris.

Defense Bases: Some pyramids see use as defensive ships, orbiting space bases for important and rich worlds. They may be heavily loaded with catapults, Greek fire projectors and ballistas, and are often hollowed out to the point where their structural stability is impaired.

A hollowed-out pyramid provides space for a wreckboat or flitter to be hidden inside, waiting to take its crew to safety should the pyramid break up. The pyramid can also serve as a protective, concealing hangar for such craft, and enable the crew of a ship to let fly with a heavy weapon barrage before joining battle with their own ship's weapons. Pyramids so modified have Armor Ratings of 2 or even 3, but hold more air in their internal cavities. One side or the bottom of such craft swings open like a huge door in 3-6 (1d4+2) rounds to permit a spacecraft to enter or leave.

Pharaoh Ships: The undead remnants of clergy faithful to Ptah (and other Egyptian gods) crew a few pyramids amid the stars. Details of the *Dark Pharaoh's* ship are given in Part II of the "Adventures" section, in "Pharaoh The Stars Than Thee." Consider detailing an encounter with greater or lesser undead crews (perhaps with a vampire or ghost serving a lich, or two liches serving some being other than the Dark Pharaoh).

GOBLIN BLADE (Kobold Arrow)

Built By:	Goblins, Kobolds
Used Primarily By:	Goblins, Kobolds
Tonnage:	2 tons
Hull Points:	2
Crew:	1/2
Maneuver Class:	A
Landing—Land:	No
Landing—Water:	No
Armor Rating:	4
Saves As:	Metal

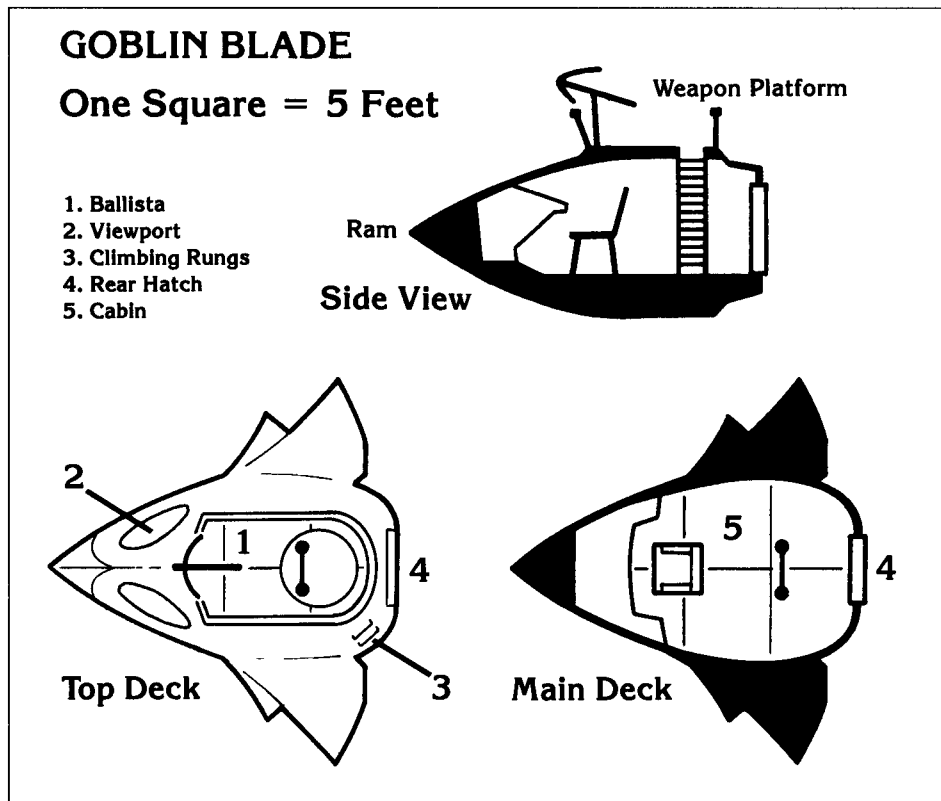

Power Type:	Lifejammer helm or Death helm*
Ship's Rating:	As for victim
Standard Armament:	1 Greek fire projector (aft) Crew: 3 Piercing ram
Cargo:	One half ton*
Keel Length:	20'
Beam Length:	20'

* See "Personal & Ship Equipment" section for details).

Goblin Blades are small, short range attack ships. Developed from the earlier, unarmored kobold arrow (which was usually unarmed), the *blade* was primarily used in kamikaze ram attacks against enemy ships in space-battles.

The aggressive and rapacious kobolds used their ships on reckless ground raids as well as space attacks. Many kobold arrows were fitted with wooden runners to enable them to

land on sand, salt pans, and flat grasslands. The skeletons of a few ill-fated arrows can still be found mouldering on worlds scattered across space.

Ogre mammoths used to carry these ships as one-way boarding boats. The goblinkin races turned to the kamikaze use when elven armadas began to press them in space.

A blade (or arrow) is shaped like an arrowhead, with the *spelljammer helm* amidships and the weapon (if any) mounted at the top rear. If unarmed, a rail-lined crew platform surrounds the weapon-mount, connected by hatch and ladder to the interior.

Many spacefaring races use ships of this design today. Goblinkin races returning to space favor it; a blade is affordable and used by enough races not to attract immediate attack. Humans and halflings find blades tailor-made for short range uses, and giff

and gnomes find them to test experimental devices.

Crew

The crew sizes for goblins and kobolds are 1 minimum and 4 maximum. Note that this allows a human captive to be used in the lifejammer, and two goblins or one human crew the ship.

Ship Uses

Boarding Boat: When outfitted as a short range boarding vessel, a goblin blade may carry a *minor helm* or may be fitted with non-helm engines. Stripped of all armor except a flame-retarding paste (AR drops to 6) and much of its hull skin, a boarding boat is crammed with coiled tether-lines, or fitted with grapnels or even gnome tangle-guns. Thirty percent of all boarding boats are unarmed; of the others; only 10% retain the Greek fire projector; 20% are fitted with a light catapult (always ready-loaded), and the rest are armed with a light ballista.

Whether the ship is armed or not, the railed aft upper platform may be outfitted with boarding pikes, shields, (regular warrior's shields) tether lines, and armored bins of oil pots ready to throw.

Ram: When used as a mobile ram, a boarding boat may be powered by a *death helm*, *lifejammer*, or even a chemical explosive rocket or giant smoke-powder flare gun (burns 35 charges per use). The latter propellant provides a one-shot, one-direction (no turning) burst of forward speed. In such cases, the ship may be unmanned, or crewed by three intrepid souls who fire its Greek fire projector, setting Greek fire projectiles within it ablaze by tossing a fiery object down the open hatch and hurriedly abandoning ship.

The flaming ship then (hopefully) rams the enemy ship and explodes, doing both multiple Greek fire dam-

age and ramming damage (an initial strike of 4-40 hit points and 1-4 hull points damage plus fire effects on following rounds, added to 1 hull point of ramming damage, plus Hull Holed and Ship Shaken critical hit results). Not bad for a single weapon—if one can afford it, and *if* one hits!

The DM should judge such situations by using an attack roll, the distance between the blade's starting point and the target, the visibility and situation (possible debris, spell effects, etc.), and the skill of those using the blade as a ram. Note that defenders of a base or world who have practiced firing an unarmed blade at wood-and-cloth targets for months will be *VERY* accurate when launching a ram.

A ramming blade that is destroyed before reaching its target is always a "miss;" it does no hull point damage, and can cause fiery hp damage (typically 2-12 points, and 1-4 on the following round) only to creatures in the immediate vicinity of the explosion. Note that this may well include the blade's crew!

Tug: A goblin blade used as a short range shuttle is often fitted with a *major helm* so that it can tow one or more cargo barges (q.v.). This extends its range (due to added air capacity) and its carrying power, and makes it useful as a cargo tug operating between a world and orbiting space vessels.

Such tugs, unable to safely land, usually make 'flying drops' of the cargo barges (which can land on water). They round up barges coming from the world which are propelled up by either chemical charges or short bursts of temporarily-fitted *furnaces* or *spelljammer helms*.

Tugs are often stripped of armor and weaponry to increase their carrying capacity. Their AR can drop as far as 6, but their internal cargo space can increase to one ton.

Escape Craft: Found only aboard the largest ships-of-the-line of the richest spacefarers—or towed by

reavers, explorers, and war armadas to whom survival is all, blade escape craft are similar to stripped-down tugs. They are usually unarmed and stripped of as much armor as the owners deem prudent, and fitted with a *major helm*, a *minor helm*, or *furnace*.

LAMPREY SHIP ("Striker")

Built By:	? (early human spacefaring race? insectoid race?)
Used Primarily By:	Humans
Tonnage:	26 tons
Hull Points:	26
Crew:	8/26
Maneuver Class:	B
Landing—Land:	No
Landing—Water:	No
Armor Rating:	4
Saves As:	Thick wood
Power Type:	Furnace (20%) Minor helm (40%) Major helm (40%)
Ship's Rating:	2 (Furnace) or as helmsman
Standard Armament:	
3 Medium ballistas	Crew: 2 each
Cone ram w/Med. ballista	Crew: 2
Cargo:	6 tons
Keel Length:	115'
Beam Length:	25'

This slim, ancient ship design is well represented in space. It is serviceable enough to have been copied by human spacefarers, as well as a few gnolls, orcs, and goblins trying to conceal their identities.

A development of the eel ship (q.v.), the lamprey was designed specifically as a fighting-craft. It is sufficiently different in performance and specifics to have a distinct entry, although the two craft are similar in appearance when seen from afar. Many

LAMPREY SHIP

One Square = 5 Feet

Side View

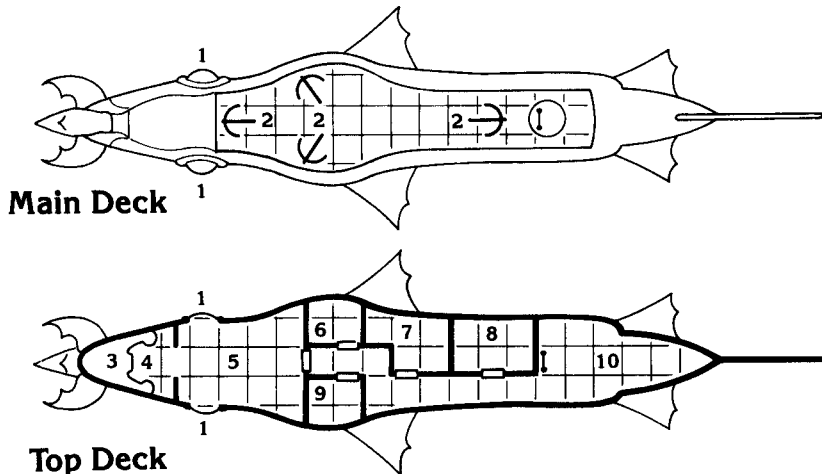

Main Deck

Top Deck

- | | |
|-------------------------|---------------------------|
| 1. Portholes | 6. Captain's Quarters |
| 2. Ballista | 7. Crew Quarters |
| 3. Grapple Machinery | 8. Mess |
| 4. Grapple Control Room | 9. Spelljammer's Quarters |
| 5. Helm/Bridge | 10. Cargo Hold |

lampreys were modified with special "jaw-grapples," operated by winches in the command cabin. When the ship rams, the grapples are tightened, crushing the ship and doing 1-2 points of Hull damage.

Crew

The usual fighting crew of this vessel is 14 to 16, yet the ship can be both flown and fought with as few as eight. The *spelljammer helm* is located just forward of amidships. The captain and navigator sit behind the helm.

Ship Uses

War Boat: Warrior Lampreys sacrifice the controversial cone ram (see below) and its ballista in exchange for a Blunt ram and an under-mounted medium catapult turret. Cargo space shrinks to a mere three tons, and practical minimum crew rises by one crewman. Fastboat Lam-

preys are gaining in popularity: they sacrifice all armament but one ballista, change the ram to a piercing type, and have an AR of 5. The Maneuver Class rises to "A," cargo space is nine tons, and the vessel is modified to land safely on water. This ship variant blurs the line between patrol craft and shuttle vessels (described hereafter).

Shuttle: Usually stripped-down vessels powered by *minor helms*, these 'runner' lampreys see common use in travel between worlds in the same sphere.

The cone-mouth is usually replaced with an upswept bow so the lamprey can land on water, and two outrigger pontoons, added for stability, are fitted aft of amidships. The aft ballista turret is emptied for use as a covered observation/firing platform. The ship retains the forward topside ballista as its only armament.

The ship may be further modified

by lowering its AR (as far as 6) and sacrificing some hull points to gain additional cargo space (to a practical maximum of 18 tons).

Raider: The mouth of an unmodified lamprey is a Cone ram—a hollow cone (with a ballista mounted deep within) surrounded by multiple piercing rams. These do more hull point damage (two points of damage times the number of hexes the lamprey charged before entering a target ship's hex) than a conventional single piercing ram. Getting stuck in a rammed ship is impossible (the strike of a cone ram automatically causes a Hull Holed critical hit effect, and allows the crew of the lamprey to launch attacks through their ship's mouth into the hole).

This apparently-brilliant design is rarely seen in space because of its drawbacks. The interior ballista and its crew are exposed to attack and debris damage (in a ramming attack, each crewman must save vs. Poison or be knocked cold for 1-4 rounds by the shock of impact). The confined quarters make attempts to avoid debris difficult—the crew must successfully fend off debris with boarding pikes. Attempts to avoid impact-shock, fiery, or blast damage are impossible.

The hollow bow itself is fragile, despite its massive weight and construction, and easily damaged in ramming (suffering 1-2 hull points of damage per ram, unless it saves versus crushing blow). This design flaw cannot be countered by further armoring the bow: it is already constructed of the heaviest, sturdiest metal plating and wooden shock-absorbing bracing possible. The materials and added spell protections add much to the cost of the vessel.

Most importantly, the ballista's firing 'mouth' and access tunnel create a funnel that transmits fiery attacks into the ship's interior. A ballista bolt fired down the mouth of a lamprey has a very good chance of causing Spelljammer Shock as it drives im-

paled ballista-crew (no avoidance allowed) and captain (Dexterity Check to avoid) into the helmsman. For such a shot to hit, the ballista must be able to reasonably fire directly down the "throat" of the lamprey and then make a hit against AC 1.

Should the crew get out of the way, the spelljammer is very likely to be skewered to the helm (Dexterity Check to avoid). Two hits against AC 3 here will damage the forward ballista beyond use.

A raiding lamprey will have a full crew if possible, and an extra two or three mercenary warriors as boarding troops. This is a risky business, as the lamprey can only stay against the hull of a holed enemy ship for 1-2 rounds, if the holed ship is able to move away. The cone ram does not provide any grip on a struck ship—it is *designed* to slide free.

OGRE MAMMOTH

Built By:	Ogres
Used Primarily By:	Ogres, Humans, Mind flayers
Tonnage:	90 tons
Hull Points:	90
Crew:	27/90
Maneuver Class:	E
Landing—Land:	Yes
Landing—Water:	No
Armor Rating:	4
Saves As:	Thick wood
Power Type:	Furnace (20%) Major helm (10%) Death helm (70%)
Ship's Rating:	2 (Furnace) or as helmsman or victim
Standard Armament:	
4 Heavy ballistas	Crew: 4 each
4 Heavy catapults	Crew: 5 each
1 Heavy jettison (aft)	Crew: 4
Blunt ram	
Cargo:	36 tons
Keel Length:	135'
Beam Length:	45'

Formerly the pride of ogre space fleets, these massive vessels have seen service since the fall of ogre power as mobile bases for human reavers and as mind flayer slaving vessels.

These metal-plated ships-of-war were the menace of the spaceways until the elven decimation of ogres and other goblinkin rendered them almost extinct. The elves decided that such ships were too powerful and too easily used for evil purposes, so they destroyed them all.

Yet many mammoths were far afield, exploring outer reaches of the flow, and escaped destruction. Some are still whispered to contain ogre crews bent on revenge, but many have since fallen into other hands.

No new ogre mammoths are known to have been built. Mammoths were always slow, heavy, and short on air. They made up for the crew discomforts and their performance shortcomings (at least in the minds of admirals who never had to fly one) by being hard-hitting war machines.

Ogres usually used slaves to life-jam a mammoth, and fitted some mammoths with auxiliary *major helms* purchased from the Arcane. Captive human wizards, controlled by spells and torture, could then be used to power the mammoth at its best possible rating (most *spelljamming helms* and *furnaces* were fitted to mammoths after they passed out of ogre ownership, to replace the hated and feared *death helms*).

Crew

The minimum crew of a mammoth is 27. Human crews consist of a captain or "warlord" who directly commands the spelljammer. There are usually two apprentice spelljammers (who may also be the ship's chaplains and healers).

Under the captain are three "bolds," or mates, each of whom commands 10 "hands" (crew).

Ship Uses

Battleship: Ogres using a mammoth in war would procure a human mage to spelljam it, load the ship with weaponry, and cram aboard as many ogre warriors as they could gather (usually 500-600; a maximum of 788 can fit), ignoring air considerations: the victorious can breathe the air of their victims, and the defeated are better dead anyway.

The captain of the mammoth would then lash 3-6 (1d4+2) kobold arrows or the later goblin blades (q.v.) to the underside of his hull to use as boarding boats or rams, and set forth to seek battle.

Slaveship: In the hands of ogres, a mammoth slaveship was simply a battleship with fewer ogre warriors and more slaves aboard. The mammoth might tow only a single goblin blade as a shuttle and to hold more food for the slaves. A typical crew was 40 or so strong.

In the hands of illithid mind flayers, however, the slave pens have been expanded and the ships modified. Illithid mammoths sacrifice their jettisons, a ballista, and three catapults each (to be mounted on other illithid ships), and sacrifice some armor (their AR drops to 6). Cargo space rises to 61 tons. After food and water requirements have been met, some 58 tons are left to carry slaves. Crew size is usually 36 to 38, composed and organized like a standard Nautiloid crew (see the SPELLJAMMER™ boxed set).

Illithids usually escort the lumbering mammoth slaveships with better-armed, more modern warships.

Reaver Flagship: A human reaver modifying a mammoth to serve as a mobile base typically dispenses with the jettison and one catapult to gain some additional interior space. This space is converted to cabins and luxurious living quarters, and in the process, usable cargo space in the ship drops to 32 tons. Other armaments are usually unchanged, de-

fense being improved by stationing flitters armed with Greek fire projectors and wreckboat escape craft nearby. Crew sizes vary widely, from the minimum 27 up to 70 or more.

Ogre Kingship: Somewhere in space, an ogre mammoth of augmented size and weaponry is said to circle a "Grey Star" or "Steel Star" (the light this fire world gives off being of dull grey hue). On it, an Ogre King holds court, sending forth ogre raiders (in captured traders, dromonds, and the like) in search of *spelljamming helms* and human mages to operate them.

The Ogre King plans the day when the ogres will rise again to carve out

a kingdom in space. The Ogre King is an ogre mage of unusual powers, and has his Iron Dukes: six ogre mages. These hunt down and slay those who spread word of the king, or any who defy his orders.

The kingship is said to mount three bombard, in a separately-armored domed section, so that if an explosion occurs, the entire dome can be jettisoned and the rest of the mammoth escapes intact. The ship itself is huge, too large for conventional *spelljammer helms* to move—and may not in fact be powered (See also *Archimperator*, below).

Mastodon: These rare vessels, ogre mammoths of the usual size,

but fitted with an armored dome like the kingship, have been encountered in the farthest reaches of space. They are rumored to be guardian vessels protecting crystal spheres near the Steel Star, and are armed with three bombard, a heavy catapult, and two heavy ballistas.

As with the kingship, the dome's armor is reinforced on all sides (to prevent an internal explosion from damaging the parent ship more than the surroundings), and the dome itself can be jettisoned. Gunnery is said to be an unpopular duty, even a punishment among ogres: the only way into or out of a bombard-dome is by climbing along the outside of the

OGRE MAMMOTH

One Square = 5 Feet

1. Observation Deck
2. Ammunition Storage
3. Ladders to Weapons
4. Crew Quarters (First Shift)
5. Crew Quarters (Second Shift)
6. Crew Common Room
7. Bridge
8. Captain's Quarters
9. Spelljammer's Quarters
10. Guest Quarters
11. Jettison
12. Cargo Deck
13. Overhead Cargo Doors
14. Sickbay
15. Armory
16. Galley
17. Mess

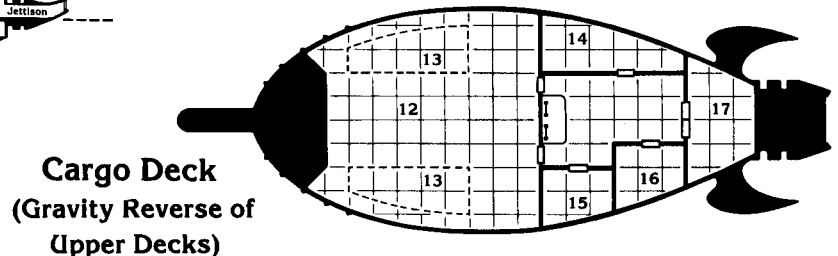
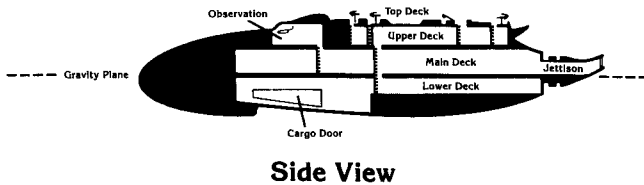
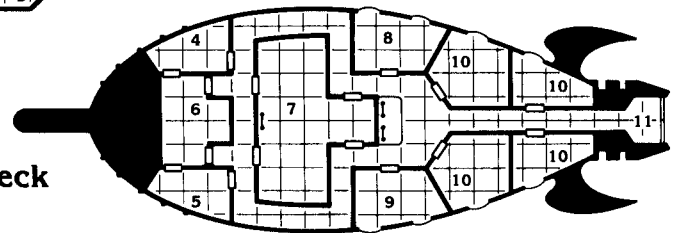
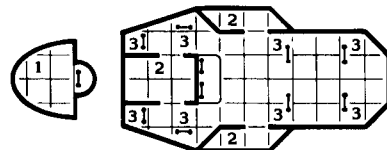
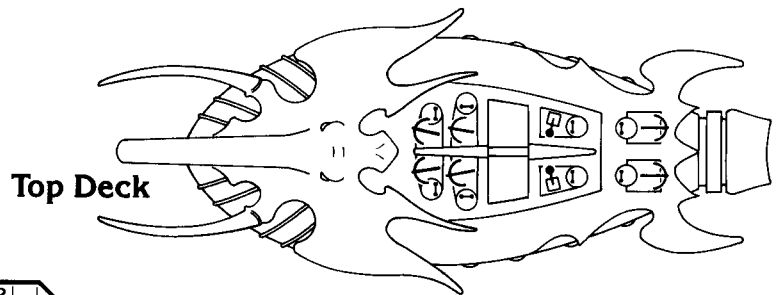



The Steel Star

Persistent space tales whisper of a fire world in a sphere far from the known spaceways, whose light is a distinctive dull grey.

Around this "Steel Star" circles a huge warship of space: the Kingship of those ogres who survived the elven purge. This vast vessel is accompanied by many smaller ships salvaged, stolen, or seized by the retreating ogres—or by the boldest of their kind raiding since.

The ogres are rebuilding, to regain a kingdom in space and to revenge themselves upon the hated elves. They are building two more kingships in nearby spheres, and are sending forth raiders to seize ships, helms, and human mages to spelljam them.

So the tales go. Yet one reliable explorer, the human mage Khelben "Blackstaff" Arunsun, has confirmed that the Kingship, The Steel Star, and the building ogre strength do exist!



hulls, on hand-lines. No internal hatches link the dome (which also serves as the ammunition magazine) with the rest of the ship.

Dinotherium: Encountered in the farthest reaches of space, these variants of the ogre mammoth seem to be of recent make. Some warn that they represent the rekindled power of ogres in space.

A Dinotherium weighs 99 tons and is constructed entirely of metal, saving as metal and having an AR of 3. Its bow is fitted with two inward-curving 'tusk rams' or 'catch rams.' These are piercing rams which do normal damage (cf. Ramming in the *Concordance of Arcane Space*), but are more likely to lock the ship and its target together (a chance of 8% times the target's tonnage).

A Dinotherium's minimum crew is 36. It mounts six heavy ballistas and four heavy catapults.

Archimperator: Elminster's colleague, the void-faring archmage Khelben "Blackstaff" Arunsun, reports that the ogres are building two more kingships, ones without bombards or space wasted on "court" functions. They are war-vessels.

The vessels Khelben saw were armed with eight heavy ballistas and six heavy catapults each, and were mounted with piercing rams.

An Archimperator weighs 160 tons, and Khelben believes that the reason these vessels have not yet begun to raid the spheres of known space is that the ogres have not yet perfected the *series major helms* they are developing to navigate their archimperators through space.

If they ever do, Khelben has warned the elves, it will be war again, war that spans the vast reaches of space, war that can only end in extermination. Elven patrols seek these menaces, but have yet to find them. At least, those patrols that have *returned at all* have seen nothing . . .

PORCUPINE SHIP ("Spine-Ship")

Built By:	Goblins
Used Primarily By:	Goblins
Tonnage:	30 tons
Hull Points:	30
Crew:	8/30
Maneuver Class:	D
Landing—Land:	No
Landing—Water:	Yes*
Armor Rating:	7
Saves As:	Thin wood
Power Type:	Minor helm
Ship's Rating:	As helmsman
Standard Armament:	
4 Light ballistas	Crew: 1 each
Ram-mines (see below)	
Cargo:	18 tons
Keel Length:	85'
Beam Length:	60'

* (many leak!)

This comical-looking, ramshackle ship type was one of the first paranoid attempts at spaceship design by the goblin race. Fairly cheap and easy to build on the surface of a world, porcupine ships appeared by the thousands in the early days of goblin spacefaring.

They later disappeared just as rapidly in the elven hunt, being no match for even the smallest elven ship patrols. A few may still be found as wrecks upon remote worlds and planetoids, or adrift as hulks.

A porcupine ship is a large wooden globe with a finned tail. Its hollow, bulbous main body holds an impressive array of sliding-collar, wooden hammer-beams through which catwalks link the ballista ports with the crew floors, helm, bridge, and the cargo holds below and aft. The sharpened ends of these massive beams protrude from the globe in a forest of deadly spikes; a ward against those who would board it.

The ballistas fire through holes set between these spines. Every third spine (and in some battle-ready ships, *every* spine) is fitted with a

PORCUPINE SHIP

One Square = 5 Feet

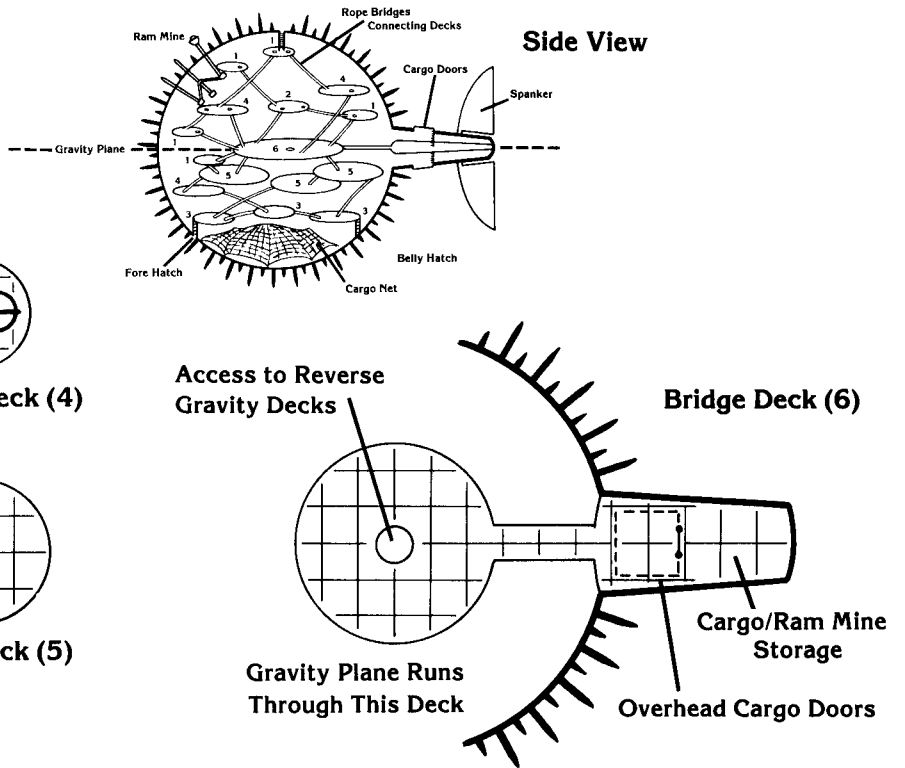
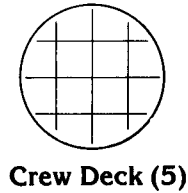
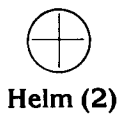

long wooden wand, and at its tip is a ram-mine.

Ram-mines are now thankfully rare. As dangerous to the user as to the enemy, a ram-mine is a waxed paper or cloth globe filled with paper packets of smoke powder. The globe is built around a wooden wand to which are affixed many small pieces of roughened steel. The remainder of the space in the globe is taken up by springy green tree boughs, bent and lashed into ovals. Each of these ovals is studded with several flints. The globe itself is cupped in a conical metal collar affixed to the wand.

When one of these complex disasters strikes another solid object, the globe is driven sharply back down the wand to the wooden spine. The violent contacts of flint and steel ignite the whole thing. The cup-like metal collar directs most of the force of the sudden explosion outward, against the struck object.

The damage done to the target is as follows: 3-18 hit points to all crew within 70' of the impact point (save vs. Spell reduces damage to 2-12), and 2-5 hull points to the vessel.

Back inside the porcupine ship, the hammer-beam recoils (with unpleasant consequences for crew—attack roll against endangered crew; a hit indicates 2-5 damage, plus Dexterity Check or be knocked cold for 2-5 rounds), but does minimal structural damage to the ship itself.

Hot metal shards from the disintegrating shields often come in through the porcupine's ballista ports, and the mine often damages several protruding beam-spikes.

Each time a ram-mine detonates, the ship must save twice against normal fire. A failure indicates 2-12 hit points of shard damage to any creature within 70' of the exploding mine. A successful Dexterity Check halves the damage.

A second failure indicates that the ship suffers 1 point of hull damage.

After a total of six points of hull damage are suffered (from this cause only), the ships must make a special save against normal fire. If it fails, a spine has caught fire, which spreads unless the crew cuts off the beam or douses it in water.

Goblin crewmen grew very patient at dismantling each and every ram-mine before entering the flow (a long and exacting process, during which the partially-disarmed ship was at risk). Occasionally a crew was desperately pursued, or was a bit tired, wounded, or rushed—and a mine or two was missed. The consequences were spectacularly final in the flow, hastening the abandonment of ram-mines as a major ship armament.

Crew

The crew sizes given are for humans. For goblins and other S-sized

creatures, the minimum is 12 and the maximum 60. A goblin crew aboard a porcupine ship had very little privacy; the captain and any off-duty spelljammers/shamans had enclosed cabins at the base of the ship's tail; everyone else slept in tiered bunks in the open globe on an open crew floor and tended to treat each other as equals.

The captain of a porcupine ship (usually a tribal chief) conferred with the spelljammer and the tribal shaman (who might be a priest of as high as 7th level).

The shaman's assistants (low level priests) or a captive human wizard of low level formed the backup jammer crew. These were under the command of the captain and his bodyguards.

These bodyguards, up to five in number, each held the rank of 'watchmaster' and commanded the goblin crewmen (called 'teeth').

Non-goblin races using porcupine ships tend to be adventurers or other small, family-like groups, and establish their own ranks and precedences. Most users of spine-ships tend to be, or desire to be, temporary tenants only.

Ship Uses

Explorer: Goblins used warships to explore, but human and halfling masters of these ships today employ a modified spine-ship for exploration purposes. The spines are cut short all over the craft, which is plated with overlapped metal or ceramic plates (AR rises to a maximum of 5). It is also fitted with landing skids for use on sand, salt pans, and other flat land surfaces. All use of ram-mines is abandoned, and the ship is fitted with a forward gang-ramp that can be drawn up or let down from within the ship.

The top of the sphere is cut away and then resurfaced to form two sloping roof surfaces rising to a central peak. On these roof-surfaces are

mounted turrets holding medium ballistas, one on either side.

Firing-ports for crew weapons are cut into the lower curve of the globe and the tail, and the original goblin armaments are stripped out and sold or junked (usually the latter).

Cargo space shrinks to 14 tons once the ship is lined and refitted. Most human owners try either to get rid of this sort of ship as soon as they can, or fit it with a *major helm* and add some speed to the craft.

Trader: As operated by goblins, these sacrificed two ballistas and most of the stored ram-mine ammunition to increase cargo space to 20 tons. The ramshackle cargo haulers offered good protection against debris (the spines flex and ward off debris), but poor protection against attack.

Human and other users of porcupine trader ships today may change one of the two surviving ballistas to a top-mounted medium catapult on a turret (cutting off upper spines as necessary to allow the turret to rotate), and abandon all use of ram-mines, but otherwise use a ship identical to the goblin-run trading version. Inability to escape noise and stink make these ships unsuitable for slave or livestock cargo.

Warship: As operated by goblins, these were armed as described above, with plentiful ram-mines stored in the tail and fitted regularly to the spines. Those few spacefarers who use porcupine ships today want nothing to do with ram-mines, and tend to mount a light catapult on the upper surface of the tail. Cargo space shrinks to about 15 tons when proper cabin fittings and cargo storage are added to the interior.

SCORPION

Built By: Orcs
Used Primarily By: Orcs
Tonnage: 60 tons
Hull Points: 60

Crew: 6/60
Maneuver Class: C
Landing—Land: Yes
Landing—Water: No
Armor Rating: 4
Saves As: Metal
Power Type: Major helm (40%)
 Lifejammer (60%)
Ship's Rating: As helmsman or victim

Standard Armament:
 1 Medium ballista Crew: 2
 2 Heavy catapults (on tail) Crew: 5 each
 2 Ram-Claws
Cargo: 12 tons
Keel Length: 75'
Beam Length: 20'

These solid, deadly warships represent the pinnacle of orc spacegoing innovation. Relatively few survived diligent hunting by the elven armadas, but most spacefarers think that orcs on scattered worlds have been steadily building new scorpions—as have other races who are able to copy them.

Crew

Twenty-four orc warriors are ample to run a Scorpion at full efficiency in battle, feeding ammunition as fast as it can be used and firing weapons as fast as they can be operated.

Orcs lacking tribal shamans have hired human mages to serve as spelljammers—even paying them handsomely and honestly. More often, these ships are fitted with two or three *lifejammer helms*, and the orcs fill these with captives as fast as they can procure them. An orc captain may be an orog (cf. Orc, in the AD&D® *Monstrous Compendium*) or orc chieftain, and is likely to have a magical item, unusual strength, or some other edge that enables him to retain his command in the face of the ambitions of his underlings.

Ship Uses

Warship: This most common form is as described above, although some non-orc owners have been known to replace a heavy catapult with a heavy ballista or make other changes. There is little to improve upon, however. For details of the scorpion's infamous ram-claws, see the "Personal & Ship Equipment" section.

No other ship type anywhere in space has been known to be successfully fitted with ram-claws, although experiments to modify the claws for more delicate use and fit them to a cargo barge (q.v.) for space mining and salvage continue.

An ogre captain is known to have fitted a blunt ram to a warship scorpion's nose, reducing its cargo space to a mere nine tons.

Those ships which attack space

bases and worlds have also added a bulbous underturret containing a heavy jettison, reducing MC to "D" and cargo space to eight tons (strengthened landing gear are needed to accommodate the turret).

Trader: Some humans who have taken possession of derelict scorpions and rebuilt them have replaced the ram-claws with a pair of conventional piercing rams (which are sometimes torn away from the parent ship when they lodge in a target, proving unpopular), and reduce the ship's armaments.

Usually one catapult is removed and the other reduced to a medium weapon. Cargo space increases to 15 tons. If the ship is stripped, up to 4 Hull points are lost, and the AR is reduced to 5, but MC increases to "B," and cargo space increases by another three tons.

Such variants are not numerous.

Most masters of scorpions are content to live with the few shortcomings of its design. Its performance as a solid fighting-ship makes it valuable as a trader in dangerous areas even in unmodified warship form.

Other Configurations

Tavern-talk hints of a (gulp!) gnome-built version of the scorpion which has recurring breakup and crash problems. Darker whispers tell of a 'super-scorpion' that orcs are developing in the farthest reaches of space, and gathering in fleets to mount a triumphant comeback to spacefaring supremacy. Elves, it is said, will be the first to go—and then these upstarts, the neogi!

SCORPION SHIP

One Square = 5 Feet

- 1. Catapult
- 2. Ratline Connections
- 3. Ballista
- 4. Helm
- 5. Crew Room
- 6. Galley/Sleeping Quarters
- 7. Lockers/Storage
- 8. Claw Machinery
- 9. Main Cargo
- 10. Ammunition/Bilges
- 11. Overhead Cargo Doors

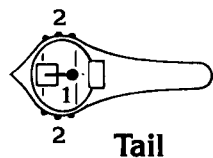

Tail

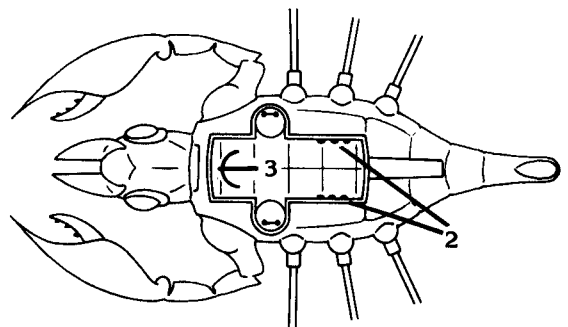

Top Deck

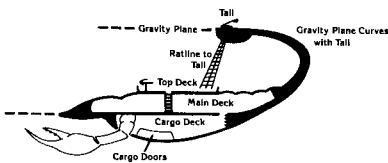

Side View

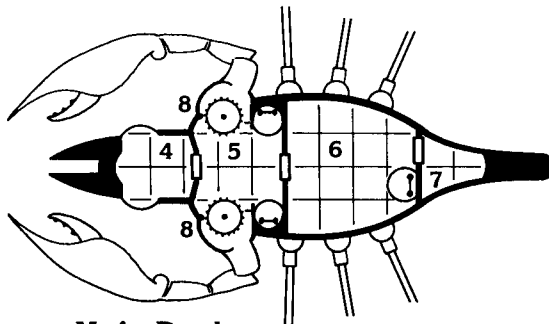

Main Deck

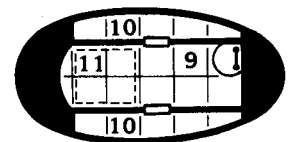

Cargo Deck
(Reverse Gravity From Upper Decks)

SHRIKESHIP

Built By: Humans
Used Primarily By: Humans, Halflings
Tonnage: 30 tons
Hull Points: 30
Crew: 14/30
Maneuver Class: B
Landing—Land: Yes
Landing—Water: No
Armor Rating: 5
Saves As: Thick wood
Power Type: Major or Minor helm
Ship's Rating: As helmsman
Standard Armament:
 3 Heavy ballistas Crew: 4 each
 1 Light jettison (aft) Crew: 2
 Piercing ram
Cargo: 20 tons
Keel Length: 100'
Beam Length: 20'

This slim, light raiding ship has been used as a fast merchant trader and a light warship by humans and halflings. It is a recent design, but is gaining popularity among private merchant traders operating in known space. If fitted with a *major helm*, it can tow one or more cargo barges for long-range or heavy-hauling voyages, yet is large enough alone for shuttle runs within a sphere.

Crew

The sizes given are for M-sized beings (a full fighting crew would be 18). The minimum and maximum numbers for halflings are 18/60.

Ship Uses

Warship: Some human and elven armadas have added this ship to their planetary defense or patrol fleets (of late, elves have been unable to grow ships fast enough to meet their increasing needs, and have taken to acquiring 'acceptable' ships like the shrikeship). In some cases, the ship is armor-plated, raising the AR to 4 but reducing MC to "C." Elves often

modify the ship to land on water, sacrificing two tons of cargo capacity and attaching outrigger pontoons for balance.

A common modification is to replace the central ballista turret with a heavy catapult, and replace the jettison with a light ballista firing down and aft.

Other Configurations

Trading or messenger modifications of this craft are being tested by several human navies. They are usually stripped (AR reduced to 6 and armament reduced to one heavy or medium ballista, for a cargo total of 25 tons). Private cargo variants tend to sacrifice the jettison and one ballista, reducing the other two ballistas to medium versions, and gaining a cargo total of 22 tons.

Raiders tend to use the ship in its warship version, perhaps sacrificing the jettison and internal comforts for a one-ton gain in cargo space.

SKELETON SHIP ("Boneship," "Flying Skeleton")

Built By: Undead humans
Used Primarily By: Undead humans (usually liches)
Tonnage: 1-12 tons
Hull Points: 1-12
Crew: 1/1-12
Maneuver Class: C
Landing—Land: No
Landing—Water: No
Armor Rating: 9
Saves As: Bone
Power Type: Major or Minor helm, Furnace, or Lifejammer
Ship's Rating: 2 (Furnace) or as helmsman or victim
Standard Armament:
 2 Medium ballistas Crew: 2 each
Cargo: up to 1 ton
Keel Length: 200' (varies)

Beam Length: 30-41'
 (29 + 1d12)

Some desperate or fey spacefarers have been sighted using the skeletons of gargantuan creatures as spaceships. The statistics of such ships naturally vary from skeleton to skeleton, but a representative version appears here.

Radiant dragon skeletons are rare indeed (at least in an intact state). Kindori skeletons are most often used—primarily by undead humans, who fit such ships with weaponry and helms salvaged from wreckage or prey, and then sail forth on voyages across space to work arcane re-ven- ges or seek obscure goals—or merely to destroy all spacefaring life, engaging in a little piracy along the way.

Several magical processes are known which preserve or augment the fluidity and stability of skeletal joints—though a few skeleton craft have been seen in which the bones are merely lashed or wired together. Kindori skeletons tend to be in the 12-ton range. Salvaged radiant dragon skeletons are almost always incomplete, lacking most of the tail and wing-bones; what is left tends to weigh around 11 tons.

Crew

The crew sizes given are for M-sized air-breathing creatures. The crew size can be doubled if a magical means of acquiring more air is used, and tripled if a deck can be lashed within the rib cage of the skeleton.

Undead, of course, have no such limits. As many as can hold onto a skeleton can come along—to a practical maximum of 100 per ship, but most crews are nearer 20 strong.

Ship Uses

Piracy: Undead pirates, particularly liches, use these vessels to plunder and raid, mounting one ballista in the jawbones of the kindori skele-

ton and the other aft of amidships, on its spine. Ballista bolts are stored tied to long tether lines running the length of the skeletal vessel. The belly-ribs support the helm.

Often such helms are *lifejammers*, into which undead crews force captives. To avoid having "waiting" captives shatter a ship while struggling for freedom, the undead crews often break all the joints of a captive, and securely truss the unfortunate into a towed bundle.

A typical undead crew encountered on such a ship is as follows: a vampire, lich, or mummy captain, served by 1-2 wights or ghosts, 2-5 ghouls or zombies, and 3-18 skeletons. Many ships have no ghouls or ghosts. Wraiths, spectres, and shadows are rare unless they are the only sorts of undead crew aboard; all three types may be found serving under a vampire or ghost captain.

Liches served only by skeletons are also a popular combination.

More unusual sorts of undead (such as banshees and poltergeists) are almost never encountered.

Personal Yachts: On occasion, liches may be encountered who have little interest in other living things (except as sources of magical spell components, new spells, and magical items). Their skeleton and zombie crews may attack living spacefarers to gain such treasures or to get 'fresh blood' for ghouls or a *lifejammer*, or they may ignore nearby ships unless attacked themselves (DMs, note that sighting and being ignored by a slowly-passing undead ship can be a chilling experience for PCs new to space).

Other Configurations

Boneships are unsuitable as cargo vessels. Attempts to tow anything will cause the skeleton to break up. The stated cargo capacity refers to small valuables only, lashed to the ship's ribs.

A skeleton also cannot support turrets, much decking, or heavy storage bins or cabins without breaking apart. It therefore cannot be 'up-gunned' much, and of course cannot be used for ramming. A ramming collision will cause an automatic breakup of a boneship, whether it strikes or is struck. A shearing attack can be made by a boneship, but the boneship itself suffers a "Crash" result (it will also suffer a "Crash" result if another vessel shears it).

Some kobolds and goblins, venturing again into space, have sought to load kindori skeletons with Greek fire or other incendiary loads, and launch them as mobile rams when attacking human bases and fleets. This works, except that the targets can readily see what is coming at them, and can often cause fragile boneships to break up and lose attacking velocity before they get near.

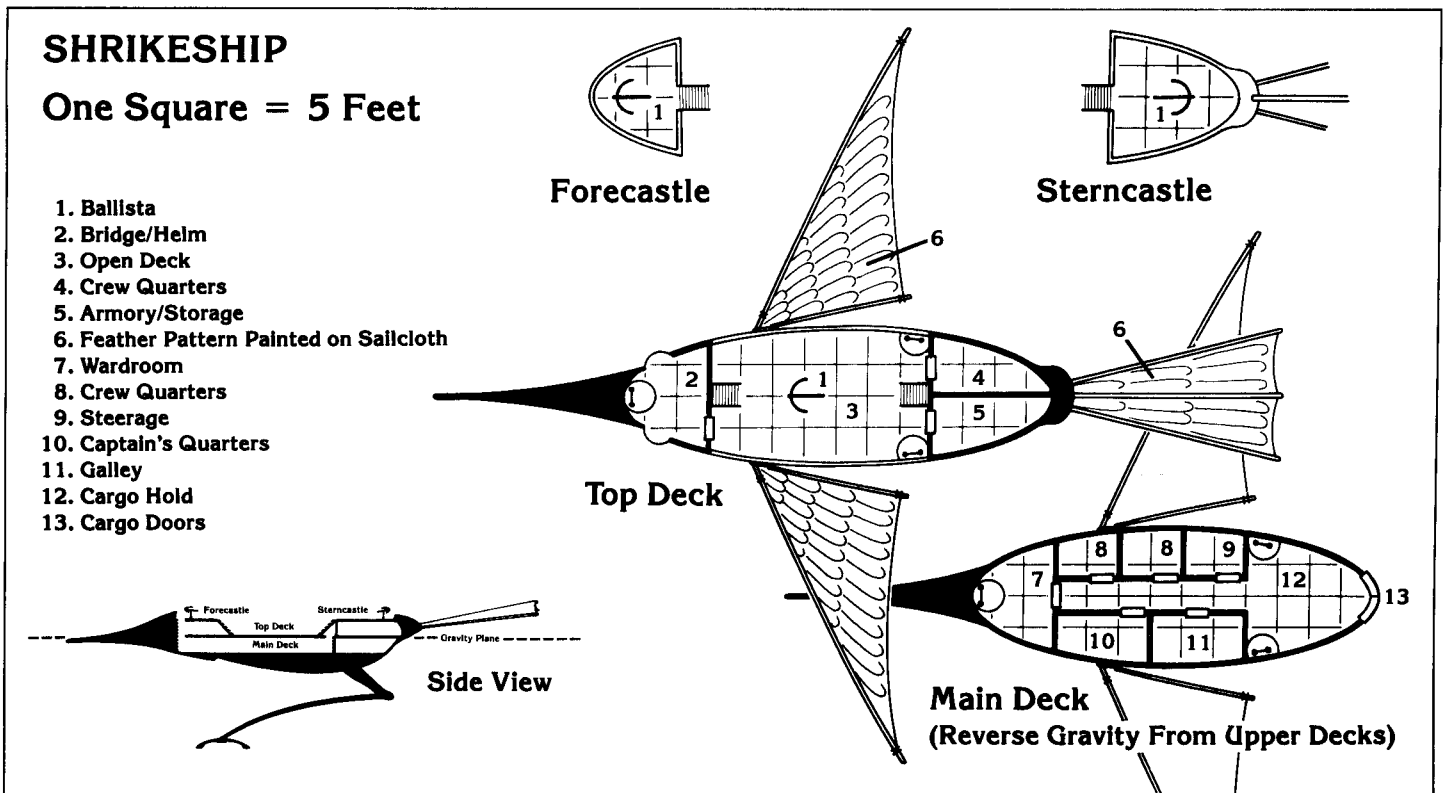



Redeyes

This distinctive space landmark is a huge crystal sphere dominated by a pair of very large, deep red fire worlds.

Lying between human- and illithid-dominated areas, Redeyes has often been a battleground. It is littered with salvageable space debris, because only the desperate or very well-armed come scavenging.

Redeys is home to at least one rogue death tyrant (q.v., *New Monsters*), lots of scavvers, and cinnamon-brown, red-eyed space-stirges (identical to normal stirges, but unaffected by temperature changes or fouled air), and a host of human and humanoid reavers.

Few Redeyes raiders have enough treasure to be worth fighting. Many trading guilds, secret societies and military brotherhoods, however, make venturing into Redeyes (and bringing back a space-stirge corpse as proof) an initiation rite.



SPACE LEVIATHAN

Built By: ? (vanished alien race—titans?)

Used Primarily By: ?

Tonnage: 400 tons

Hull Points: 400

Crew: ?/400

Maneuver Class: F

Landing—Land: No

Landing—Water: No

Armor Rating: 3

Saves As: Metal

Power Type: ? (some sort of Series super-helms?)

Ship's Rating: ? (As helmsman)

Standard Armament:

8 Heavy catapults Crew: 5 each

3 Bombards Crew: 3 each

Blunt ram

Cargo: 290 tons

Keel Length: 306'

Beam Length: 96'

Only a handful of badly-damaged wrecks represent this truly "lost" type of spaceship. Very old and very large, metal hulks of strange grandeur drift in widely-separated areas of known space—one in the depths of the Sargasso of Seven Stars, one near Redeyes (a pair of very large, red fire worlds located in a huge crystal sphere that has often been a battleground), and one in the flow near Realmspace. There are others undoubtedly yet to be discovered.

The Arcane refuse to say anything about them when asked (even when offered money). These ships are large enough to serve as bases or hiding-places for spaceships, and their metal is of a strange type not easily worked—and that crumbles with the fatigue of age, so the known wrecks are useless as sources of salvageable metal.

Dwarves can make no use of space leviathans (although they keep experimenting with the strange metal),

but several spacefaring races have moved the great hulks to serve as orbital bases—and even, in battle, as rams to force enemy ship formations apart. Such movement is done by towing or pushing with multiple, carefully coordinated conventional ships, and is both dangerous and very tricky.

A more popular use of leviathan wrecks is by raiders, who enter the interior of hulks by means of the large holes torn in their hulls, and hide within. A wreck can serve as a base, a repair area, or simply as a hiding-place from which the reaver can rush out to ambush another ship.

Some human sages believe that the size of the wrecks indicates that their crews must have been of giant size—perhaps spacegoing titans of old.

Elven sages generally counter that this is simply another case of human thinkers blithely interpreting everything by assuming that another race thought and acted as humans.

Given greater magic, the elves say, there is no reason why a race that voyaged in space for long periods of time—or even lived in space all the time aboard these vessels—should not have built very large ships. The *spelljammer helms* known today may not be able to move them, but perhaps other means, now lost to us, could. Or perhaps these ships were not meant to move at all. The truth (as yet) remains hidden.

Crew

All crew size estimates are based on M-sized creatures. Not enough is left of any of the wrecks to speculate even what sort of creatures built them, other than they had similar vision to humans, were M-sized or larger, and were skilled at working metal. All of the known wrecks seem to have been cast, or grown, or somehow formed out of a *single piece of metal*; there are no seams or joins except where hatches, viewing ports,

SKELETON SHIP

1. Ballista
2. Decks Lashed to Skeleton Ribs
3. Helm

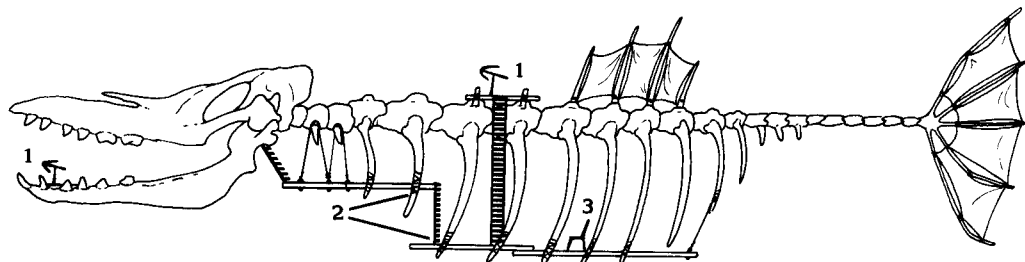

and obviously-damaged breaks are found.

Ship Uses

Unknown.

STONESHIP

Built By:	Xorn
Used Primarily By:	Xorn
Tonnage:	300 tons
Hull Points:	300
Crew:	54/300
Maneuver Class:	E
Landing—Land:	No
Landing—Water:	No
Armor Rating:	0
Saves As:	Stone
Power Type:	Foundry (10%) Series death helms (20%) Elemental Power (70%)
Ship's Rating:	1 (Furnace) or As victim

Standard Armament:

8 Heavy catapults	Crew: 5 each
2 Heavy jettisons	Crew: 4 each
3 Blunt rams	
Cargo:	75 tons
Keel Length:	250'
Beam Length:	200'

These rare ships are simply solid or nearly solid asteroids fitted with weapons and used by spacegoing xorn (whose forays into space are rare and mysterious). Some sages believe that spacegoing xorn are searching for a way into an alternative elemental plane of Earth, one

that is not frequented by cruel dao. Others believe they simply seek to colonize a perfect world of their own.

These ships are sometimes captured by dwarves, who convert them into citadels. Battles between xorn and dwarves in the heart of a stoneship are vicious, protracted affairs that may rage for years.

Xorn were once believed to get all of their spacegear from the Arcane in exchange for mined gems or by seizing ships that have set down on worlds. It is now known that they have devised a way of using *death helms* in series, to power their huge ships. These horrible power sources drain 4-24 hit points per day from any being put into them and the xorn are constantly in need of beings to feed them. Stoneships so fitted have many hatches on their surfaces, leading to slave-pens where such 'fuel' is kept.

A more recent and efficient means of powering stoneships is the harnessing of fire elementals, using some secret magical process. Xorn are so determined to keep this power source for their own exclusive use that they will power down and banish all apparatus and traces of its use whenever intruders are detected within the surface of a stoneship.

Elminster and Khelben both believe that the process involves powerful magic and the use of sealed, interior caverns. Xorn phase into and out of such caverns, where others cannot.

This argues the existence of powerful xorn mages, or at least the abil-

ity of xorn to handle powerful magics. Many sages ridicule this idea, citing as proof the fact that xorn encountered on worlds seem uniformly uninterested in powerful magic, and do not seem to possess (or at least use) any themselves.

Elminster has countered that we know so little about the xorn that it is folly to rule out such mastery of magic. He points out that one could say that dwarves use magic little, and are seldom encountered on worlds hurling spells about—and yet, they, like the xorn, can be found in space, using magical forces to power ships.

Xorn have long lives—600 to 700 years is not uncommon, and at least one living xorn is older than 1,100 years. The xorn spacefaring captain known only as "Oxblongh" is over 960 years of age.

As long as they are fed, xorn are also relatively passive. For these reasons, they are content to let a stoneship drift along, unpowered, until they have destroyed or driven away intruders, rather than risk discovery of their means of power. Xorn power does not work in the flow. Xorn stoneships inch through the flow very slowly, by means of mechanical steering paddles and xorn "ramjets." These latter devices are carefully shaped tunnels through a stoneship that take in phlogiston, compress it in a series of chambers by mechanical means, and expel it out the 'rear' of the stoneship in weak jets that propel the asteroid v-e-r-y slowly through the flow.

Some xorn ships in the flow have

been observed to work slaves to death (because, it is suspected, the xorn lack the food to keep them) working huge oar-like sweeps mounted on the outer surfaces of the ships. These also move a massive stoneship along very slowly—and often attract the attention of slavers who want the slaves for themselves.

Too little is known of xorn to determine if they are friendly or hostile as a group to any of the other spacefaring races. They are an enigma, to be approached with caution by all who venture into space.

Crew

The crew sizes (including gun crews) given are for M-sized creatures; estimated xorn crew numbers are: 8/40, and two per weapon. If *life-jammers* are used, slave prisons must be included in the 75 tons of cargo space.

Ship Uses

Explorer: Only xorn are known to use unaltered stoneships. They appear to use them for one purpose only; exploring space for usable worlds, and carrying xorn colonists to those worlds. A stoneship appears as a spelljamming asteroid, recognizable by the massive stone rams that jut up from its surface (the only known vessel that can practically mount more than one ram at a time).

Xorn live in the solid interiors of stoneships, retreating through the rock to avoid personal damage. Note that a stoneship can never suffer Hull Holed or Interior Crew Strike critical hit results.

Few of these ships exist in space at any one time. Xorn are not enthusiastic spacefarers, and dwarven attacks add to the severity of the crash landings that occur when a stoneship lands on a world. Stoneships are un-

popular and risky places for xorn.

Many stoneships have been taken over (often forcibly, in mid-voyage) by dwarves. Others can be found lost in the flow, or crashed and abandoned on worlds colonized by xorn.

Other Configurations

None known, unless one considers those partially transformed into dwarven citadels.

SWAN SHIP

Built By:	Halflings
Used Primarily By:	Humans, Halflings, Elves
Tonnage:	32 tons
Hull Points:	32
Crew:	12/32
Maneuver Class:	C
Landing—Land:	No
Landing—Water:	Yes

TURTLE SHIP

One Square = 5 Feet

1. Ballista Deck
2. Catapult
3. Bridge
4. Helm
5. Captain's Quarters
6. Spelljammer's Quarters
7. Strongroom
8. Crew Quarters
9. Sickbay
10. To Cargo Deck
11. Fin Machinery
12. Retractable Ramp

Top Deck

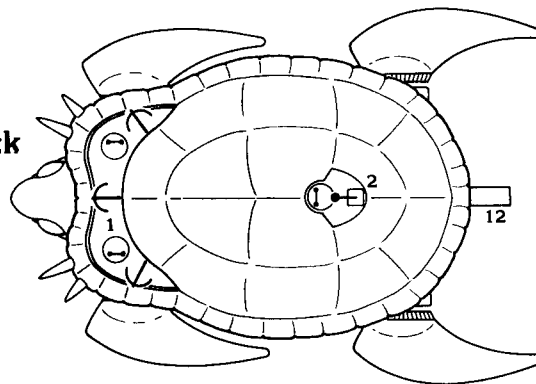

Flippers Rotate in Counter-clockwise Direction

Main Deck

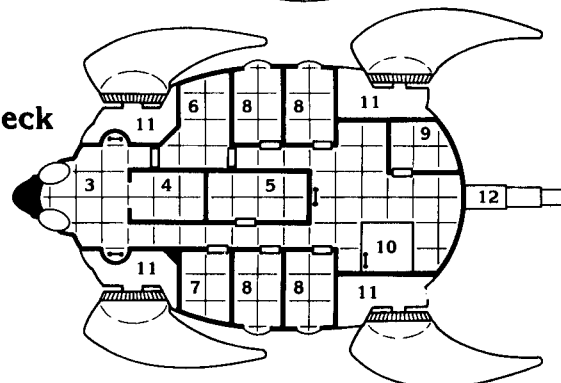

Side View

SWAN SHIP

One Square = 5 Feet

- 1. Ballista
- 2. Bridge
- 3. Viewports
- 4. Captain's Quarters
- 5. Spelljammer's Quarters
- 6. Open Deck
- 7. Tail Catapult
- 8. Galley
- 9. Mess
- 10. Crew Quarters
- 11. Passenger Quarters
- 12. Head
- 13. Baggage/Storage
- 14. Lounge
- 15. Ammunition Storage
- 16. Cargo Hold
- 17. Cargo Doors
- 18. Wing Control Room
- 19. Paddle Room
- 20. To Wing/Paddle Machinery

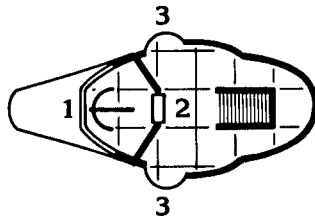

Bridge Deck

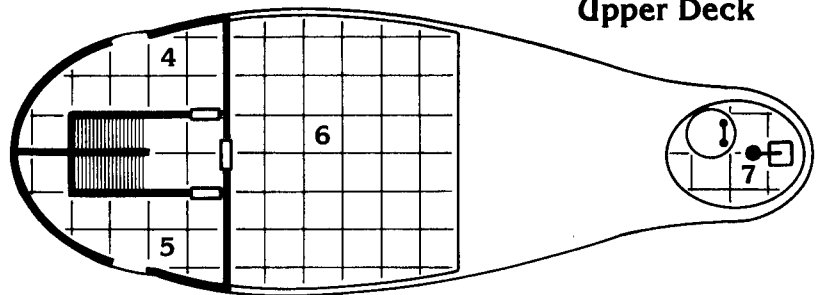

Upper Deck

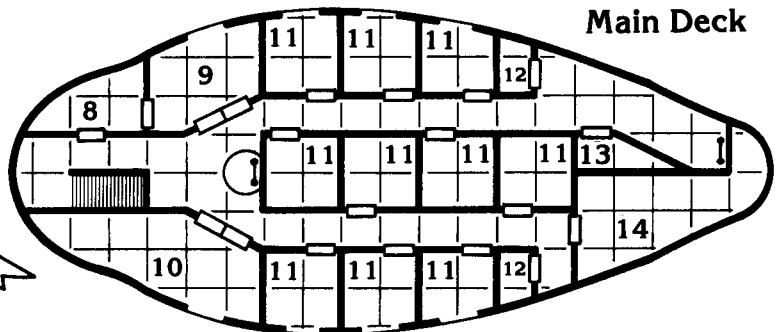

Main Deck

Catapult (Aft View)

Tail Section Folds Down to Reveal Catapult

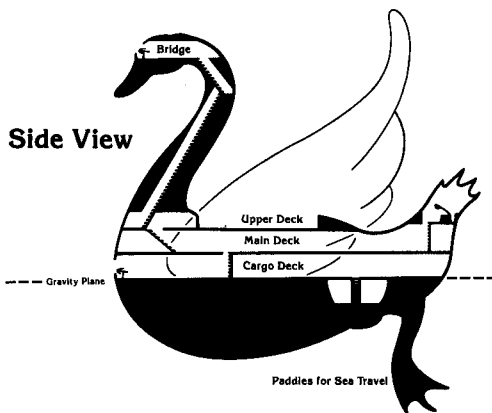
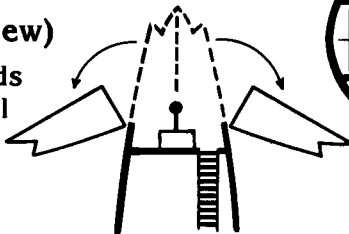

Side View

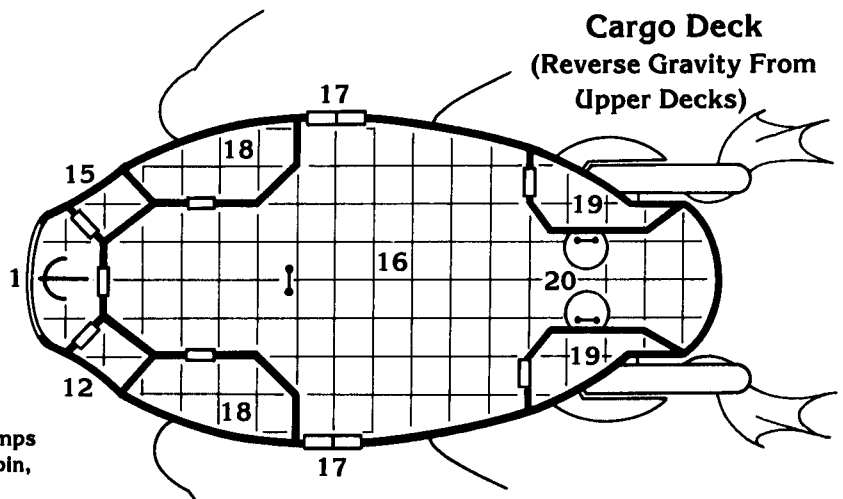

Cargo Deck
(Reverse Gravity From Upper Decks)

Wings can adjust to horizontal positions to act as ramps for cargo loading. When raised, will protect guest cabin, portholes, and upper deck.

Armor Rating: 7
Saves As: Thin wood
Power Type: Major or Minor helm
Ship's Rating: As helmsman
Standard Armament:
 2 Medium ballistas Crew: 2 each
 1 Heavy catapult (aft) Crew: 5
Cargo: 26 tons
Keel Length: 100'
Beam Length: 40'

Perhaps the best spaceship design yet devised by the "half-folk," this is another of the rare designs deemed acceptable by elves and purchased for inclusion in their navies.

Crew

Figures given are for humans. Halflings and other S-sized creatures have a crew minimum of 16 and a maximum of 64.

Ship Uses

Trader: A graceful and sturdy merchant vessel capable of crash-landing on grasslands or beaches and remaining spaceworthy. Not a great battlecraft, but serviceable, and gaining popularity with human spacefarers. Slightly larger than traders (see SPELLJAMMER™ boxed set), they are less sturdy but can carry twice the cargo.

Other Configurations

Many swan ships have been modified for warship use, with a variety of heavier weaponry. Every ship seems different. Spacefarers are warned that illithid and giff raiders and slavers have begun to modify swan ships. An innocent-looking swan ship sighted in space may be a deadly foe.

TURTLE SHIP ("Battle Boat")

Built By: Lizard men
Used Primarily By: Lizard men,

Tonnage: 40 tons
Hull Points: 40
Crew: 12/40
Maneuver Class: D
Landing—Land: Yes
Landing—Water: Yes
Armor Rating: 3
Saves As: Metal
Power Type: Major helm (25%)
 Minor helm (75%)

Ship's Rating: As helmsman
Standard Armament:
 3 Light ballistas (forward) Crew: 1 each
 1 Medium catapult (aft) Crew: 3
 Blunt ram
Cargo: 28 tons
Keel Length: 95'
Beam Length: 70'

A rugged scalykind trader-ship design popular with humans (especially pirates and free traders who run dangerous routes and fight often), turtle ships have a distinctive shape and appearance. A recent design (perhaps the best devised by lizard men so far), they are just beginning to appear in numbers.

Mind flayers have been quick to seize turtle ships, turning them to slaving uses.

Crew

An average lizard man merchant crew is 26. The captain is a warrior of 9th or greater level, and at least 16 of the crew are warriors of at least 3rd level. There are also at least 2 crew shamans. The *spelljammer helm*, deep in the center of the ship, is usually manned by a hired human wizard, but on occasion, lizard men priests (and, it is rumored, lizard man mages) take the helm.

Illithid slaving crews are of similar strength, and include no slaves for safety reasons.

Ship Uses

Trader: The trading configuration of the turtle ship is the version described above, dominated inside by damp, dim, crowded tunnels radiating outward from the central 'wet pool.' An eerie, flickering yellow-green radiance comes from the *spelljammer helm* when it is in operation. Much of the rest of the ship is dark.

Warship: Lizard men now use it almost exclusively for exploration and escort duty, and to patrol major spacekind worlds against increasing neogi and illithid slave-raiding.

A battle boat carries a crew of around 30, always having at least three shamans and at least three wizards. Also in the crew are three warriors of 7th or greater level, and the captain (generally 10th-12th level).

The armament changes to three heavy ballistas and one heavy catapult, and the ship is stripped inside. The power source is always a *major helm*, with a *furnace* as backup. Maneuver Class rises to "C," but cargo space shrinks to 14 tons. Fearful of losing such powerful ships to enemies, lizard men fly battle boats in pairs or threesomes.

Slaver: Mind flayers (and a few humans) modify turtle ships for slaving by altering the weaponry and draining the 'wet pool'. The former pool is fitted with portable, barred box cages (with manacles in their corners).

Sometimes the *spelljammer helm* is replaced by a *lifejammer*, by three *series helms*, or both (the *series helms* kept as backup).

VIPERSHIP ("DarkViper")

Built By: Humans
Used Primarily By: Humans
Tonnage: 29 tons
Hull Points: 29
Crew: 1/29
Maneuver Class: A

VIPERSHIP

One Square = 5 Feet

- 1. Ballista
- 2. Catapult
- 3. Helm
- 4. Cabin
- 5. Galley/Pantry
- 6. Cargo Hold
- 7. Jettison
- 8. Cargo Doors

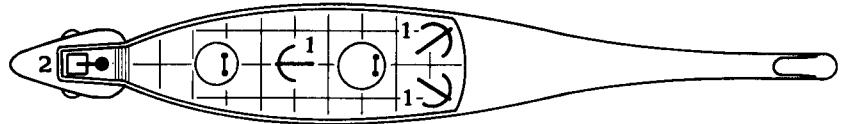

Top Deck

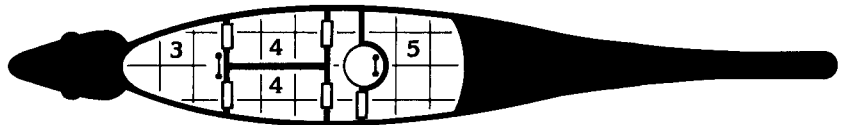

Main Deck

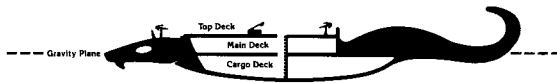

Side View

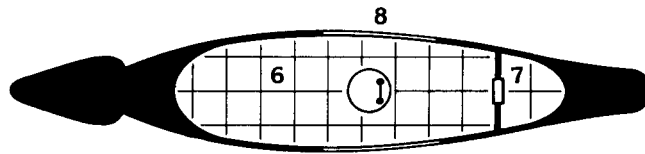

Cargo Deck
(Reverse Gravity From Upper Decks)

- Landing— Land: Yes
- Landing— Water: Yes
- Armor Rating: 5
- Saves As: Metal
- Power Type: Major helm (75%)
Minor helm (15%)
Furnace (10%)
- Ship's Rating: 2 (furnace) or as helmsman
- Standard Armament:
3 Medium ballistas Crew: 2 each
1 Light catapult Crew: 1
1 Heavy jettison (aft, below)
Crew: 4
Piercing ram
- Cargo: 16 tons
- Keel Length: 125'
- Beam Length: 15'

The most successful early human ship design, viperships were popular with navies, 'grey traders' (merchants dealing in illegal goods), pirates, and explorers.

Sleek and graceful, most fell into

WRECKBOAT

One Square = 5 Feet

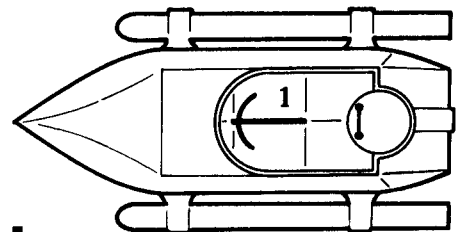

Top Deck

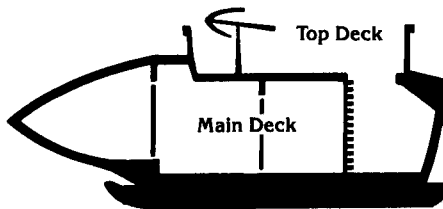

Side View

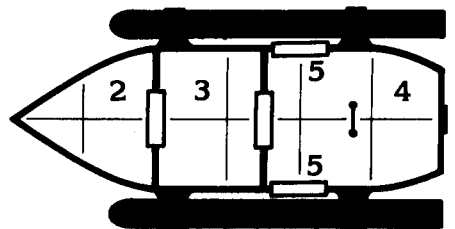

Main Deck

- 1. Ballista
- 2. Cabin
- 3. Helm
- 4. Cargo
- 5. Watertight Access Doors

the hands of orcs and goblins who slew their human owners, and were later destroyed by elven armadas. The elves seized a few in battle and sold them to humans. At least one race took apart their purchase and soon began making their own.

Refitted viperships have become favorite vessels of "wonderseekers" (q.v., "Men: Wonderseekers," in "New Monsters").

Crew

The usual wonderseeker crew is one man, alone or with up to three companions. Non-wonderseeker crews tend to be 12-16 hands strong.

Ship Uses

Darkviper: This is the version described above; the ship any wonderseeker will fly. These swashbucklers run cargo on occasion to raise extra cash, but usually just wander space seeking fun. Lone wonderseekers cruise with all weapons loaded.

Wonderseekers make deadly, persistent foes if angered. Some launch wild, reckless attacks, and others play a shrewd waiting, stalking game—but a wonderseeker always has the time (and nothing more important to do) than to *get* you.

Fireviper: This experimental version is being developed by space-faring humans. It is met on merchant-escort duty in dangerous areas, and in world-defense.

It is re-armed and heavily armored (AR rises to 4, MC drops to "B"). Two ballistas and the jettison are replaced by two bombardments in turrets (range and damage as a "typical" bombardment, in the SPELLJAMMER™ boxed set rules). The ship's cargo space is further armored (chance of a critical hit igniting the powder magazine drops from 10% to 6%) shrinking to nine tons, and is filled with smoke powder charges (a rich prize if captured intact!).

Stingviper: This variant serves in world or sphere defense. The tail jet-

tison is replaced by a heavy ballista (hence the ship's name), and the three medium ballistas upgraded to heavy. Maneuver Class drops to "B," and cargo space to 12 tons.

Most Stingvipers have a *major* and a *minor helm*. If the *major helm* is knocked out, the backup *minor helm* in the tail is used. Two spelljammers are always on duty.

WRECKBOAT

Built By:	Humans
Used Primarily By:	Humans
Tonnage:	4 tons
Hull Points:	4
Crew:	1/4
Maneuver Class:	A
Landing— Land:	Yes
Landing— Water:	Yes
Armor Rating:	6
Saves As:	Thick wood
Power Type:	Minor helm
Ship's Rating:	As helmsman
Standard Armament:	None (60%)
	1 Medium ballista (40%) Crew: 2
Cargo:	see below
Keel Length:	30'
Beam Length:	15'

Named for its original intended use (as a short range escape vessel), the "wreckboat" name is used in a derisive sense today—most human crews consider it a "wreck waiting to happen" amid the dangers of space.

"Cargo" in a wreckboat is personal gear and small valuables only, to a maximum of a half ton if the crew is two or less, or a quarter ton if the crew is larger.

Wreckboats retain their original use, but their everyday function is as a shuttle or captain's gig. They are usually towed by spacegoing ships that never make planetfall. Concealed with *invisibility* to reduce theft, a wreckboat is always protected with a *retain air envelope* spell (see SPELLJAMMER™ boxed set) to keep its air clear of any disasters that

might befall the mother ship. It must be regularly inspected and kept clear of flow barnacles, spaceworms, and the like.

Crew

The spelljammer alone can fly this ship easily, although when landing a crew of at least one hand is useful. If the ship must fight, a three-man crew is necessary to man the ballista (and operate personal weapons out of the hatches, if desired). A fourth man will make ammunition carrying much easier in a fierce fight, and (if capable) can back up the gun crew or the helmsman.

Ship Uses

Attack ship: Some wealthy kings and wizards have purchased wreckboats to use as gigs (they make spell component- and monster-gathering expeditions faster, and allow for true shuttle diplomacy).

Wreckboats make useful attackers when besieging castles or routing rebel armies (particularly if loaded with fire pots and other missiles). For such uses, a four-man crew is a must.

Gig: The most popular use of a wreckboat is to pick up and let off passengers on worlds in an inconspicuous manner. A priest usually travels aboard so that the boat's *retain air envelope* spell can be dropped within the world's atmosphere, the air replenished, and then another *retain* spell cast before the atmosphere is left. The gig version is as described here, although the armament may be changed or removed entirely.

Lifeboat: Up to nine M-sized beings can use a wreckboat for a short descent to a world from a stricken ship. If the weapon is left behind, the empty turret can shelter another three beings. Removal of all ballista ammunition will allow another being aboard. Air supply becomes a problem if overcrowding is tried for anything longer than short hops.



This section details new spells for the reaches of space. Most are not willingly taught or sold, and will be unknown to Player Characters unless they seize means to learn them while adventuring.

Wizard Spells

Third-Level Spells

Airsphere (Alteration)

Range: 10 yards/level
 Components: V,S,M
 Duration: Permanent
 Casting Time: 3 rounds
 Area of Effect: 20-foot radius
 Saving Throw: None

This creates a mobile sphere of breathable air, identical to the atmosphere of the caster's home world or land. This air can be fouled with use as other atmospheres, but drives out and displaces any fouled air it contacts within the first 12 turns of its existence.

The air comes into being around the caster, but does not mix with the surrounding atmosphere. During the first three turns, the caster can mentally move the airsphere in any direction, at a rate of 90' per round, to the limits of the caster's range. Thereafter it is no longer under the caster's control, and obeys the gravity of nearby objects.

This spell is often used to aid a stranded being in space by hurling air to him. Its material component (broken during casting) is a small crystal or glass sphere holding air.

If an airsphere contacts a fiery explosion in the phlogiston, the fiery area expands to the limits of the airsphere and fouls it. Beings within this expanded area of effect suffer double normal fire damage.

Fourth-Level Spells

Spark Burst (Evocation)

Range: 20 yards + 10 yards/level
 Components: V,S,M

Duration: Instantaneous
 Casting Time: 4
 Area of Effect: 20-foot radius
 Saving Throw: 1/2

This spell agitates the matter of phlogiston or atmosphere in a chosen location, releasing electrical energy. The spell can work through a crystal sphere Portal or across void wildspace to other atmospheres, but has no effect on a void.

In atmosphere, this spell damages all beings in the affected area equal to 1 point per caster level, and may detonate explosive or flammable substances touched by its sparks.

In phlogiston, the sparks ignite all flammables in the area of effect (with possible additional damage), and ignite the phlogiston. All beings in the area suffer 1d4 points of damage per caster level. For every 10 dice of damage of a *spark burst*, 1 hull point of damage is dealt to any ship in, or partially in, the area of effect.

In the flow, this spell does not en-

danger the caster, because the electrical energy does not emanate from him, occurring only at a distance. The material components are a piece of flint and a chunk of ferrous metal, of any size.

Fifth-Level Spells

Flyfield (Alteration)

Range: 30 yards + 10 yards/level

Components: V,S,M

Duration: Special

Casting Time: 1 round

Area of Effect: 5 tons of connected objects (i.e., ship, cargo, and crew)/level

Saving Throw: Special

This allows the caster (or another on whom the spell has been cast earlier, who activates the spell by speaking final words of power) to cause a powerless, drifting spaceship to suddenly lunge through space in a desired direction and distance, up to the limits of the caster's range. It is commonly used to move ships away from ramming attempts or collisions, escape missiles in combat, or to dart through crystal sphere portals.

The spell activator need not have any spellcasting ability, and may activate it even if the words of activation cannot be heard due to magical *silence* or other circumstances. The spell activator has total control over the ship's direction and distance.

For the spellcaster to designate another as the spell activator, the two must touch each other as the spell is cast. The activator must then be taught the final words of power while holding the dissipating crystal sphere (see material components, below). If the activator speaks those words again within the time-period of effectiveness, the spell instantly takes effect (or is wasted; see below).

The incomplete spell remains effective for one day per level of the caster (e.g., a 16th-level wizard could

cast the spell, and at any time within the next 16 days speak the final words—and the ship that he was in would instantly lunge as chosen).

If no direction is chosen, choose one at random, using the rules governing "Grenade-Like Missiles" in the *Dungeon Master's Guide*.

If the *activator* is killed or *feeble-minded* between casting and the end of effectiveness period, the spell is lost (normal sleep or unconsciousness do not count).

If the activator is in contact with two ships when he activates the spell, nothing occurs. The spell's magical field can be centered only on the activator and on a single ship.

This spell will not work with any ship currently under power (i.e., being moved by spelljamming, a *furnace*, or other power source), but will work in wildspace, phlogiston, and atmospheres alike. It cannot affect a ship whose total tonnage (atmosphere excluded) exceeds the limits of the caster's area of effect—if tried, the spell is lost.

The material components are two small pieces of any metallic, magnetized substance (or natural lodestones) and a small sphere of crystal.

Sixth-Level Spells

Disable Helm

(Abjuration, Alteration)

Range: 10 yards/level

Components: V,S

Duration: 1 round/level

Casting Time: 1 turn

Area of Effect: 1 helm

Saving Throw: Special

This spell temporarily scrambles an operating helm within range. The caster suffers a 1d4 hit point loss when casting the spell, draining personal life energy to power it.

The selected target must be within the caster's line of sight. If the target has no helm operating when the spell is cast, it is wasted.

The affected helm instantly ceases operating, and cannot be activated again by *any* means until the spell expires. There is no saving throw.

A saving throw is allowed for helmsmen. If successful, only 1-3 hp of damage are suffered, accompanied by intense but brief head pains. If failed, 1d6 rounds of unconsciousness result with a loss of 1 hp per level of the caster of the spell. No known means will allow early revival of an affected spelljamming being.

Eighth-Level Spells

Create Atmosphere (Alteration)

Reversible

Range: 10 yards/level

Components: V,S,M

Duration: Special

Casting Time: 6 turns

Area of Effect: 1 cubic mile volume/level

Saving Throw: Special

This difficult, unreliable spell creates not merely air, but a magically self-renewing atmosphere which survives for one standard (28-day) month per level of the caster, unless altered by contact with other atmospheres. It will last until exhausted or until the reverse of this spell is cast—*dispel magic* has no effect.

The atmosphere can be cast on any size object, and will remain with it regardless of the object's gravity or state (e.g., if a ship is destroyed, it remains centered on the largest chunk, or a random fragment, as the DM desires). This created atmosphere will replenish the atmosphere of other ships it encounters, but cannot be cast on living things.

This spell requires a small, stoppered flask and a drop of water. One hit point is permanently drained from the caster (a *wish* or *limited wish* can restore it), each and every time this spell is cast.

Destroy Minor Helm (Alteration)

Range: 10 yards/level (line of sight)
 Components: V,S,M
 Duration: Instantaneous
 Casting Time: 1 turn
 Area of Effect: 1 helm
 Saving Throw: Special

If cast on a *minor helm*, it utterly destroys the helm seat and the spelljamming magic. The helmsman operating the helm at the time suffers electrical damage equal in effects to a *spark burst* (see above), plus a possible 1d4 turns of unconsciousness and 1-3 days of 'magic death' (inability to regain spells). A save vs. Spells allows escape from the latter two effects. A helmsman who is at least 20 feet distant from the helm before the casting is complete will avoid personal damage.

If this spell is cast on a *death* or *major helm*, it reduces the affected ship's Ship Rating by 1 point for 1d12 turns (multiple *destroy minor helm* spells cause cumulative SR loss, each spell having its full normal SR damage effect, so that effects may overlap). The spell also knocks a *major helm* out for 1-2 rounds (the helmsman must save vs. Spells to avoid a 1d4 hp loss and 1 round of unconsciousness; if successful, no damage is taken).

Lifejammers, *pool* and *series helms* are utterly destroyed by this spell. Beings in the helms suffer the same potential damage as those using a *minor helm*, except that a *lifejammer* receives a beneficial discharge of energy: typically regaining 2-8 hp at the same time as the unfortunate being is harmed by the *helm's* explosion.

The spell renders *foundries* and *furnaces* inoperative for a (random) period of 2-5 rounds.

The spell's material component is a pinch of dust, which must have once been part of a magic item, or which received a long-lasting *dweomer*.

Collapse Portal (Alteration)

Range: 20 yards + 10 yards/level
 Components: V,S,M
 Duration: Instantaneous
 Casting Time: 2 rounds
 Area of Effect: 20-foot radius per level
 Saving Throw: Special

Few know how to cast this spell, though almost every spacefaring being has heard dark tales of it cutting ships in half by closing a crystal sphere.

The material components are two smooth stones of any size, one of diamond and the other of obsidian. This magic is unreliable; in place of a saving throw for the sphere, the caster must make an Intelligence Check to avoid inexplicable failure. If a *create portal* spell has been cast nearby (a 1-mile radius) during the past turn, the Check is made at a 3-point penalty.

If the Check succeeds, the crystal sphere closes around the rift or Portal. If the two-round casting time brings a ship near the sphere as spellcasting is completed, roll a d10 to determine just when the sphere closes. The following results apply:

1-2: Portal closes before the ship reaches the sphere; the ship must turn or ram the shell.

3-5: Portal closes just before the ship reaches the sphere; the ship unavoidably rams the sphere.

6-9: Portal closes on the ship, cutting it cleanly in two pieces.

0: Portal closes after ship passes through.

A ship ramming or being cut by a crystal sphere sustains both Spelljammer Shock (spelljamming mage or beings must save vs. Spells or die) and physical damage.

A ramming ship suffers Ship Shaken effects and loses 10 hull points (a ship with 0 hull points breaks up immediately).

A bisected ship also breaks up immediately, its atmosphere dividing between the two parts of the ship. De-



side randomly just where the break occurs. All beings at risk should save vs. Death Magic at +3 to avoid being slain by the slicing sphere material, and all items at risk should save vs. Disintegration to avoid destruction.

Ninth-Level Spells

Destroy Major Helm (Alteration)

Range: 10 yards/level (line of sight)
 Components: V,S,M
 Duration: Instantaneous
 Casting Time: 1 turn
 Area of Effect: 1 helm
 Saving Throw: Special

This very rare spell only affects a magical power source within range of the caster. The source need not be operating, but must itself be seen by the caster during casting, not merely the ship which houses it!

If cast on any sort of *spelljammer helm* (including *death helms*, *lifejammers*, *pool* and *series helms*, and *furnaces*), this spell utterly destroys the physical helm seat and the spelljamming magic. The being operating the helm suffers electrical damage equal in effects to a *spark burst*, plus possible unconsciousness (1d4 turns) and 1-3 days of 'magic death' (inability to regain spells). A save vs. Spells (at -2) allows escape from the latter two effects.

Any being within 30 feet of an operating helm on which this spell is cast must save vs. Spells (without bonus or penalty) to avoid suffering 2d4 electrical damage. If the helm is not operating, the spell still destroys it, but the danger zone from electrical discharge is smaller—a 15' radius.

These effects also apply to dwarven *foundries*, but these can usually (85%) be repaired, in 1d100 turns of constant work by skilled dwarves.

The spell's material component is a pinch of dust, which must have once been part of a magic item, or which received a long-lasting *dweomer*.

Priest Spells

Fifth-Level Spells

Debris Barrier (Alteration)

Sphere: Guardian
 Range: 5 yards/level
 Components: V,S,M
 Duration: 1 round/level
 Casting Time: 5 rounds
 Area of Effect: Up to five S-sized objects (space flotsam)/level
 Saving Throw: Special

This spell allows a priest to animate non-living chunks of space debris (man-size or smaller) into motion. It is effective in wildspace, phlogiston, and atmospheres alike.

The debris must already be present (it's the spell's material component) and not contained or part of a larger mass. Its size cannot be altered by the spell, unless it shatters upon contact with a target. The debris whirls about within an oval area, which the priest can use as a barrier or direct about as an offensive weapon. Beings contacting or within this field suffer 4d4 damage per round. All ceramic, bone, and glass items contacted by a *debris barrier* must save against crushing blow once per round of contact.

The debris field moves at a rate of 19, MC: "C," and can be moved about within range as long as the caster concentrates upon it, remaining stationary if the priest casts another spell or is rendered unconscious. A *dispel magic* will end it.

Flyfield (Alteration)

Sphere: Guardian
 Range: 20 yards + 10 yards/level
 Components: V,S
 Duration: Special
 Casting Time: 1 round
 Area of Effect: 5 tons of connected objects (i.e., ship, cargo, and crew)/level
 Saving Throw: Special

This magic is similar to the wizard spell of the same name, except that unlike the wizards' version, it cannot be activated by anyone other than the caster.

Seventh-Level Spells

Create Atmosphere (Alteration) Reversible

Sphere: Creation
 Range: 10 yards/level
 Components: V,S
 Duration: Special
 Casting Time: 4 turns
 Area of Effect: 1 cubic mile volume/level
 Saving Throw: Special

This spell differs slightly from the wizards' version. It requires no material component. The reversed spell, *destroy atmosphere* does not destroy an existing atmosphere, but alters it from clean to foul (or from foul to deadly). This alteration can quench flames or lessen fiery damage in some cases.



Equipment

Flash Lamps

Cost: 10 gp

Signalling has always been a concern in space, but widespread systems of signalling have proved hard to establish and almost impossible to keep in use. Pirates use false signals and develop secondary meanings. Warships of all races use ever-changing codes, and the same signal may mean different things depending on the race or world of origin of the crew using it.

Three amber lights is usually understood as a distress signal, however—and two flashes of blue or green light from an unknown ship means it wishes to pass in peace (or at least, wants those seeing the lights to believe as much).

In wildspace, many ships use “flash lamps” of readily-ignited plant spores or pollen, lit within a hooded glass pot with colored sides, so that amber, blue, red, etc. can be shown. Most have “flares” of mixed metallic flakes and spores that produce a bright white light in a three-hex diameter area, lasting 2-5 rounds.

Lines and Tethers

Hand weapons (axes, swords, pistols, etc.) are often tethered to the wielder by cords. These are typically 20 to 40 feet long, and woven of the strongest fibres and horsehair, waxed and wrapped with silk to give it great strength (3-6 points of chopping or sawing damage to sever it).

Tethered gear that is knocked out of one's grasp can be hauled in and retrieved. One can also hurl tethered weapons into another ship's rigging and be towed along, or haul oneself in hand-over-hand to escape one ship and reach another. On the other hand, in a fight one can be hauled helplessly by one's tether-line, so using them is a matter of choice.

Greener space sailors seem to prefer tethers more than old hands.

Some ships have rail-lines: hand-grip lines running along the gun-wales. Others have catch-lines: cross-deck ropes attached to bulkheads and collars low on the masts, to provide handholds for sailors working the rigging, a place for laundry to dry—and in battle, a way to snag low-flying intruders. Such lines are often left slack, to be snapped tight by a sudden tug around a bulkhead pulley to endanger enemies. For the results of striking a line, refer to “New Rules.”

Some ships are equipped with line-guns or grapple-guns; devices which fire an end-weighted or grapple-headed line into space. These are typically loaded with almost a quarter-mile of line, and can fire the head of the line 200' distant from the gun in a round (it will slow to 160' in the second round, and continue at that rate thereafter, as it pulls free of the ship's gravity). The “New Rules” section covers characters catching and being hit by lines.

A grapple-gun may be built from scratch by a skilled weapon-maker for 700 gp, or modified from a medium or heavy ballista for 400 to 300 gp, respectively. A rare sort of line-throwing gun developed by gnomes is described under Gnomoi Gear.

Top-quality lines and tethers typically cost 1 cp per six feet of length. Lines over 300' in length cost 1 sp per six feet of length.

Heavy shiptow or mooring cables (for towing cargo barges and disabled ships, and are as thick around as a child's head) can withstand 9-11 hp of damage before being severed. They weigh far too much to be used or even carried overland, and cost 1 gp per six feet of length.

Tools

The same variety of tools is found in space as can be seen on the worlds

within it (with obvious limitations, such as no flame- or spark-producing implements in phlogiston). One type is so widespread and useful as to deserve mention here.

Stow-Nets and Stow-Pods: The danger of free-flying gear aboard a ship in combat is lessened by lashing gear down with nets or pods, or by securing it in closed, barred or latched cupboards.

Nets are cocoon-shaped bags of close-meshed hemp netting, clamped or even tied permanently to wall-bars in a ship. They open along a central seam, by means of drawstrings. New nets cost 5 sp to 6 gp, depending on size and materials. Custom sizes cost 10 gp each.

Pods are large, natural containers of vegetable material, grown by large jungle plants on many worlds. They are more fragile than nets (but much cheaper to obtain; free for the cutting to a crew in the right place), but soon dry out and split unless kept oiled or damp.

Pods vary in size and shape, but all hold their shapes by their own strength, tightening as they dry out rather than loosening to spill their contents. They are typically slit open lengthwise to clean out the seed-and-fruit innards, and to insert and remove cargo. Most are lashed around the middle against severe shocks, but under normal conditions, stay closed of their own strength.

Pods can be bought from space-faring suppliers for 1-8 sp each, depending on size and condition. Large, very fresh pods might cost 1 gp each.

Ship Weapons

Cone Ram

Cost: 200 gp per ton of ship

This special type of ram is found only on lamprey ships (q.v.). They

are expensive, fragile, hard to fit to other ship types, and have some serious shortcomings.

A cone ram does more damage than a conventional piercing ram: two points of damage times the number of hexes the ram-equipped vessel charges before entering a target ship's hex. Getting stuck in a rammed ship is impossible (a cone ram strike automatically causes a Hull Holed critical hit effect, and allows the crew of the ramming ship to launch attacks through their ship's mouth into the hole thus created).

This apparently-brilliant design is rarely seen in space because of its drawbacks. The forward ballista and its crew are exposed to attack and debris damage (in a ramming attack, each crewman must save vs. Poison or be knocked cold for 1-4 rounds by the shock of impact). The confined quarters make avoiding debris difficult—the crew must fend it off with boarding pikes—and attempts to avoid blast, impact-shock, or fiery damage are impossible.

Giff Guns

Cost: 6,000 gp
 Range: 4 Hexes (2000 Yards)
 Damage: 3-18 Hit Points and 2-5 hull points of damage
 Crew: 2
 Loading
 Time: 1/2
 THACO: 17 Critical hit on 20

The newest giff weapon is the disposable gun. These dangerous wonders fire only one shot. If things work as planned, the projectile goes one way, the gun breaks loose and flies the other way, and the ship remains stationary.

They use prodigious amounts of smoke powder per shot (20 charges) and misfire (explode when lit for full damage on the ship on which they are mounted) on a 1 in 6 chance. Misfire damage is doubled in the flow,

with an effective personnel damaging radius of 40' (half that in wild-space or atmospheres).

Glass Grenades

Cost: 3 gp + ammunition (varies)

A number of races use sealed containers of glass as missiles in space combat. These are primarily used in close-quarters fighting on the decks or within ships, where the glass grenades can be expected to shatter on impact with bulkheads, decks, and ceilings, although in rare instances, they have been strewn in space to serve as mine fields.

Some unusual grenade ammunition loads may be encountered. Lizard men and other reptiles, for instance, are immune to the effects of space spore rhizomes—and actively hunt this species of gas spore. Its rhizomes affect non-reptiles just the way those of other gas spore species do. Lizard man ships commonly have ready caches of rhizome-filled glass grenades at all hatches.

The costs of any contents, from rusty nails to smoke powder, are variable. Such weapons are not popular among the prudent. Even non-combat accidents can make them deadly aboard ships, and a severe hit in combat can cause more damage to the crew than enemy weapons.

Hull Regenerator

This is more of a dream than real, usable ship gear—yet persistent human spacelore tells of mages devising versions of it, and whispers over the years hint that the Arcane have their own versions.

A "hull regenerator" is thought to be a spindle-shaped, heavy, metal artifact carried within a ship. It is activated by mechanical means, glows cherry-red when activated, and through some unknown (presumably magical) process, generates an intense but localized *field of restoration*

that 'heals' 2d4 hull points of damage, including closing holes in the hull.

This one-shot device is itself eaten up in the healing process, and irresistibly *repels* all living things within a 20' radius while operating. It apparently does not damage living beings, and works its healing within 2d12 rounds.

Sages caution that while many adventurers have heard of these handy devices and searched for them, not one reliable human trader has ever produced one for sale or inspection.

Ram-Claws

Cost: 10,000 gp each (new)
 8,500 gp each (used)

These are the infamous main armament of the now-rare orc scorpion ship (q.v.). Several races have experimented with fitting salvaged ram-claws onto other ship types, but with limited success.

The ram-claws of a scorpion are operated by the captain and his second, using levers set around them in seats located in front of the helm. A ram-claw may strike once per round at a target in the same hex only, to either hit or grab.

Each claw should roll to hit (THACO 15) twice per round. Two successful hits means a grab can be made; a single hit means only a hit is possible.

For a blow, roll 1d4. Results of 1 and 2 mean 1 and 2 points of hull damage are dealt. A result of 3 means 2 hull points and a Ship Shaken result against the target. A result of 4 means a Hull Holed (but *not* a Ship Shaken) result and 2 points of damage to the target.

A blow that strikes a character does 2d12 damage. Items on or held by struck characters should save against crushing blow, and a successful Strength check is required to avoid falling (items must save again vs. fall, but a being takes damage

only if falling onto a ship or a world below).

A 'grab' punches holes in the target's hull (Hull Holed critical hit result, and 3 points of hull damage) or shears off superstructure (depending on what the claw was grabbing at), and allows the ships to be 'grappled' for up to 2 rounds before the claws slip free from whatever they're grasping. The claw controller can free them in the next round to strike again, if desired.

A grab closing on a character does 4d12 crushing damage, takes the character off his feet, and forces all items worn or carried by the character to save versus crushing blow at -1. Grasped characters may wriggle free in 2 rounds.

If held in the round after being grasped, a character may automatically strike the claw, but may not cast spells or perform intricate activities (such as drinking potions, reading, picking locks, getting items out of backpacks, and the like). If the claw tries another grab, the character goes free automatically. If the claw, still grasping the character, strikes again, the character receives 1d12 further damage. A claw cannot throw characters; if released, they fall.

The jaw of a claw is considered to have 30 hit points (3 hull points) for purposes of breaking it, to render further grab attempts impossible. These hull points should not be added to a scorpion ship's total hp or considered part of that total for damage purposes.

The base-joint or 'shoulder' of a claw is considered to have 40 hit points or 4 hull points for the same determinations. Again do not add them to the ship's hull point total.

Construction of a ram-claw from scratch requires lots of metal. Note that claws that see use require lots of repairs, typically costing 4,000-6,000 gp per year.

Rigging Shears

Especially popular with races whose ships have little or no rigging (such as illithids), these once-popular devices are rarely seen in space now. Consisting of large, sharp metal cutting blades fastened to the prows and keels of ships lacking rams—and sometimes even to the masts and spar-ends—these deadly things were intended to cut up an enemy ship's rigging (and any crew in it).

Unfortunately, rigging shears are more dangerous to a friendly crew and to other parts of the ship using them, than to any enemy. They make repairs a hazardous job at best—and if used in battle, have a habit of working loose, so that at some later time, they suddenly fly or fall off, with dire consequences for beings or items who get in the way.

Consider all emplaced shears to launch an attack (at THAC0 7) on adjacent enemy ships whenever the shear-equipped ship and an enemy are grappled. Shears hit automatically when a successful Shearing Attack (see the SPELLJAMMER™ boxed set rules) is performed.

In all cases, no damage will occur if the situation makes it impossible (No rigging? No damage!). Otherwise, shears cut lines, sails, etc. to a total of 1/2 hull point per attack that succeeds. Shears are especially effective against towlines and anchor lines.

Against crew, shears do 1d12 damage per strike. If a being is within 10 feet of a shear and the ship or the being is moving, roll an attack for the shear at THAC0 9. If able to move freely, the target is allowed a Dexterity Check to avoid "successful" attacks.

Shears typically cost 1 gp each; equipping a ship normally requires 6 shear blades per ton. Few outfitters use or will agree to equip a ship with shears; these are usually 'do it thyself' projects for adventurers.

Spring-Spear Traps

These goblin favorites are anti-intruder traps set within an abandoned ship, or mounted in a ship's hull to fight would-be boarders. They are long, narrow wooden boxes, each crammed with a spring and a spear. When tripped, the spear fires for 1d6 damage. Each trap is a one-shot weapon, but are often arranged in pairs or triples, so that avoiding one trap puts a being into danger from the next.

Magical Items

In the descriptions that follow, "XP Value" refers to the experience gained by a being who successfully makes (*enchants*) the magical item in question. It is not an experience award given to a being who merely comes to possess it.

Anti-Magic Egg: This egg-shaped container of oil-darkened steel bears only an engraved rune. If the rune is touched and a secret command word spoken, the *egg* is activated. A 'one-shot' magical device, it slowly melts away (causing no physical damage, even if held). All magic within 30' must save (as their base material versus "magical fire" at -5, plus item magical bonuses) or be drained. Scrolls and potions must save (each spell on a scroll saves separately).

Artifacts or *helms* "drained" by an *anti-magic egg* are nullified and 'dead' for 2-5 turns; chargeable items lose 1d12 charges and are 'dead' for an alike amount of time. Spellcasters within range who have spells memorized must save vs. Spells or instantly forget one spell (select at random). Spell-like natural powers are unaffected, but cannot be used within the 30' range of the *egg* for 1d4+4 rounds after the egg is activated (the time the *egg* takes to entirely disappear).

The method of making such *eggs*

is known to many priests and mages, but each who knows it keeps it secret. The crafting is said to be a long and expensive process—thought by some to be the work of the Arcane. Well-traveled sages, such as Otiluke of Oerth, know that the Arcane try to purchase or destroy such devices whenever they can, and believe *anti-magic eggs* to be weapons devised for use against the Arcane. Otiluke believes the means of making such eggs to be among the earliest triumphs of human magic, or perhaps the work of long-ago renegade elves.

Elminster thinks them the work of illithids, perhaps working with humans or drow. Calling these *eggs* a human invention is pure hubris.

XP Value: 4,000

Armor of the Arcane: A few of these blue giants have been encountered wearing magical armor. The Arcane will not sell or give away this armor, and its stability is often (75%) linked to the wearer's life. If the Arcane is slain, the armor slowly melts away, dissolving despite any magic or process used to try to stop this.

Armor of the Arcane magically alters in size to fit the wearer, and confers AC 3 protection. Two hit points of every physical attack striking the wearer are suffered by the armor, and are not subtracted from the wearer's hit points. It protects the wearer from all forms of natural or magical mental influence and control attempts, and similarly makes him immune to the effects of poisonous vapors.

It also prevents cantrips and all spells of third level or less from affecting the wearer, absorbing the spell energy for its own maintenance. A suit of *Armor of the Arcane* can absorb 12 + 1d20 hit points of damage before dissipating. Consider the contact of any spell to give the armor additional hit points: 2 per spell level, with a cantrip giving a single point, unless the spell is one that normally deals damage. In such cases, the damage the spell would have

done is gained by the armor as additional hit points of its own.

All hp damage dealt by spells of fourth and greater levels is suffered directly by the armor, until it is destroyed. All other spell effects (such as spells which do not cause damage) of such higher-level spells affect the wearer directly, bypassing the armor's protection completely, unless they involve poisonous vapors or mental attacks.

Finally, *Armor of the Arcane* confers 90'-range infravision upon any wearer who does not possess this power naturally. The armor itself saves as metal against all attack forms requiring a saving throw, with a +3 bonus.

An Arcane who sees a non-Arcane wearing such armor will challenge the individual. Anyone impersonating an Arcane needs telepathic powers, not merely illusions, to be successful, and must know much of the Arcane society, values, and aims.

The challenging Arcane will offer the armor-wearer whatever magical item he or she desires most in return for the armor—and the tale of how the being came to be wearing it.

If the wearer refuses the deal, demands an artifact or too much magic in return, or offers the Arcane an unbelievable tale, the Arcane will call on other Arcane, or its hired minions and direct them to attack the armor-wearer. It then returns, invisible, following the armor-wearer to see where it goes and who it has dealings with, until the attack it has called for comes. It will continue to hire attackers until the armor is destroyed or surrendered. The Arcane doesn't care if this involves the death of the armor-wearer.

XP Value: Unknown (method of making not discernible to PCs)

Battle Star: This mighty magical dwarven version of the morning star is highly prized, especially by giff and certain barbarian spacefaring tribes. Dwarves do not willingly part

with them—it is death to own one if you meet most spacefaring dwarves.

A magical *battle star* of the dwarves is a +4 weapon (1d6+5 dmg to L-sized creatures). It can be wielded by S-sized creatures without penalty, and is no heavier than a non-magical morning star.

When it hits, a *battle star* of the dwarves flashes forth a bright radiance, called 'starfire.' This light blurs the vision of those not expecting it, causing them to attack at -1 to hit during the following round. The radiance also causes all magical or enchanted items within a 10' radius to momentarily glow, in sympathy.

A *battle star* can be thrown for normal damage, but will not return to the thrower. It does double damage against golems, other magically animated (not summoned or controlled) creatures and guardians, and giants.

The touch of a *battle star* causes all magical glyphs, symbols, wards, and runes to momentarily glow (without discharging them), thus revealing all magical traps.

The touch of a *battle star* also destroys magical *holds* and *locks* on both creatures and objects. The bearer cannot be *held*, and receives a +4 bonus on all saving throws against *charm* spells and other forms of magical control.

XP Value: 3,500

Beacon Helm: Sold by the Arcane, this special type of spelljamming *major helm* is fitted with silent, unlimited-range alarms. When the helm is in use—and only at such times—its direction and (very roughly) its distance will be apparent to any being holding or wearing a specialized ring.

These rings must be fashioned together with the helm in question, and cannot be linked to an existing helm. They are fashioned of adamantite, each fitted with a single large blue carbuncle. If the stone is shattered (each is AC4 and has 7 hp) or removed from the ring, that ring is for-

ever ruined as an alarm-beacon. Alarm beacons are silent, but can be felt by the wearer, and the stones in them flash and pulse visibly when the alarm is 'on.' At such times, any spellcasting attempted by a ring-wearer will not be successful. Material components won't be consumed or spells lost to memory, and no spell effect will occur. Beacon rings do not block the functioning of imbibed potions, spells read from scrolls, or the activation of magical items.

The wearer of multiple beacon rings can discern between up to three different helms; the wearing of additional beacon rings will cause all such rings to cease to function until at least one is removed. These rings can be worn next to the skin anywhere on the body, and will still function normally.

The Arcane do not release the secrets of making such *beacon helms* or rings to anyone, and no *beacon helm* specimens fashioned by neogi or others have yet been observed.

A *beacon helm* typically costs 300,000 gp with a single beacon-ring included, plus 60,000 gp per additional beacon-ring, when purchased from the Arcane. Resale prices tend to be 40,000 gp or more higher, for each component—and of course, with any one or two ring and helm combinations, one can never be sure that there isn't a third ring out there somewhere, worn by someone or something dangerous or at least unfriendly.

XP Value: Unknown (method of making not discernible to PCs)

Belt of the Arcane: This is the most common and least powerful of the broad, cummerbund-shaped belts worn by Arcane. They rarely sell such belts, but will not challenge individuals they encounter wearing one. Such belts have been traded or sold by Arcane in the recent past, and some have been found in space-wrecks and treasure caches.

By turning a stud on the belt, a

wearer who knows its secrets can *levitate* at a given height. This allows the wearer to rise or descend through the air gently, or appear to walk upon water. There is no limitation on the number of times this power can be activated, but turning it on or off requires at least 1 round.

The belt can also shed magical *light* or *darkness* in a 20' radius around the wearer. Identical to the effects of the wizard spells, these effects affect the belt wearer just the same as others, and last up to 6 rounds at a time (though the wearer can end them earlier). Once either of these belt powers is used, the belt will not repeat the particular effect until a complete turn has elapsed from the end of that power's use. The belt may be removed without ceasing to function—i.e., the wearer may create darkness, slip off the belt, and leave it to creep blindly toward a known exit to make an escape.

The belt has one additional power. By proper manipulation of its studs, the belt-wearer can raise a *wall of force* twice a day, such a wall lasting for up to 4 turns (or ending instantly, earlier, if the belt-wearer so desires), and covering an area identical to that of the equivalent spell as cast by a 16th level wizard.

The belt's studs all lock into place, and cannot accidentally be manipulated by a casual swipe or jostle. The belt appears to be leather with a metal boss, but it saves against dangers as if it were entirely metal, gaining a +3 bonus.

XP Value: Unknown (method of making not discernible to PCs)

Crown of the Void: This plain metal circlet functions continuously and automatically, and need not be worn or displayed openly. It magically creates a continually regenerating breathable atmosphere about itself, identical to the air about the maker at the time the *crown* was enchanted.

The extent of the atmosphere cre-

ated by a *crown of the void* varies from a 10' radius to a 90' radius area, centered on the crown.

In space, this item can be used to keep a drifting individual alive indefinitely, or to continually renew the atmosphere of a ship. The air created by the crown will drive out fouled or poisonous gases in its area of effect in 1-2 rounds. Note that ships using such crowns can be much tinier or far more overcrowded than ships retaining atmosphere by normal gravitational means.

The size of a crown's air envelope is mentally controlled by the being wearing the crown, who must be sane, conscious, and not engaged in spellcasting to change it. The air envelope cannot be 'turned off' or extended beyond a 90' radius, and when being willfully changed, alters in area by a 10' radius per round.

The atmosphere of a *crown of the void* cannot be 'stolen' by a larger body in space, but is magically maintained about the *crown*. If the *crown* is destroyed, the atmosphere is destroyed instantly. If an operating *crown of the void* is placed in an operating furnace and used to power a ship, it ceases to function instantly.

A *crown of the void* should not be confused with a *crown of the stars*. These items are very difficult to make. The few mages who know how to make such *crowns* usually lack some very rare ingredients necessary for the crafting.

XP Value: 4,000

Dead Box: This term refers to a stone box constructed of atharstone, a rock found in many asteroids and a few mountain ranges on planets. The box's sides are made of solid slabs of the stone, sealed with natural rubber mixed with gorgon's blood.

A properly made dead box completely and utterly foils any means, either magical or natural, of detecting the presence of any magic, residual dweomer, alignment aura, or

heat differential within the box (when such detection is attempted from outside the box).

Dead boxes may be of any size (from small rooms to tiny coffers), but all are very heavy: athar-stone is both heavier and far more durable than lead. To work, a *dead box* must be "airtight." It is rumored that the name of the box comes not only from the magic-dead properties of such boxes, but from the fate of a mage or other fool who tried to hide in one to escape detection.

XP Value: 300

Death Helm: This rare sort of spelljamming helm appears identical to all sorts of helms—that is, it may be a seat of any design or style. A *death helm* drains the lifeforce of the being using it to spelljam, precisely as a *lifejammer* does (draining 2-12 hp per day of operation; cf. *Lifejammer* in the *Concordance of Arcane Space*.)

It has one horrible refinement, however; any intelligent being sitting on the helm must save vs. Spell at -3, or be *charmed* (as the first-level wizard spell *charm person*.) The powerful *charm* makes them intensely enjoy the feeling of spelljamming and regard the helm as a place of comfort and safety.

Charmed helmsmen act normally in all respects, except that they will resist attempts to remove them from the helm. Its magic prevents them from feeling any weakness or other ill effects as they waste away.

Spelljammers in a *death helm* have been known to fight comrades trying to remove them—soldiering on at the helm until they suddenly crumple and die in a matter of seconds as the last of their lifeforce is taken.

Any being who successfully saves against the initial *charm* of a *death helm* will sense that something is wrong or dangerous about the seat, and will ever after mistrust it (+2 on all future saves against that particular *helm's charm*, not -3). A *death*

helm's charm does not extend beyond the seat itself, and is not detectable separate from the spelljamming power of the helm itself. In spelljamming performance, it is identical to a *lifejammer*, except that it can move spacecraft as a *major helm*.

The secrets of making *death helms* are not openly acknowledged by any individual or spacefaring race, but too many of these fell devices are found in modern ships for their making to be a secret lost in time.

XP Value: Unknown (method of making not discernible to PCs)

Discus of Disenchantment: It is not known who devised these odd weapons—small, sharp-edged, circular metal plates with thick centers that taper smoothly toward the edges. Often used by halflings (who may sell them to humans, elves, and giff), *discuses* are missile weapons, and may be used without penalty by those proficient in slinging.

A *discus* striking a being causes 2-5 hp of damage, and interrupts any ongoing spellcasting or activity requiring dexterity. It forces a Dexterity check on climbing characters or those clinging to rigging, to avoid falls. Its strike also forces saving throws (vs. *Crushing Blow*) for glass and other fragile items it strikes.

All magical items except *helms* and artifacts struck by a *discus of disenchantment* must save vs. Spells at +2, in addition to any usual bonuses) or be rendered magically inert for 2-5 turns. The DM should also make another, secret saving throw for any such inert item. If it fails, it has been drained of all magic, forever. Any *discus* striking a magical item exhausts its own magical powers at once, releasing this magical energy and that of the drained item instantly, untraceably, and harmlessly into the surroundings.

Such a *discus* can of course drain items it is carried or stored with!

XP Value: 500

Gemsword: These very rare, ancient long swords were devised by the earliest spacefaring elves. Over the ages, the secrets of making and repairing them have been lost. Only the Arcane and certain archmages know how to recharge them.

Gemswords are +4 weapons of electric-blue metal (a very fine sort of steel). Slim and bejeweled, with ornate twisted and curlicued hilts, they are beautiful to behold, and prized by all spacefarers.

Gemswords constantly gather light energy from nearby sources, and once per day (a 144-turn period) can be commanded to make a power strike.

A power strike requires a to-hit roll (if failed, the blade flashes with light, loosing its stored energy harmlessly).

Upon hitting, it deals 1 hull point of damage to a ship, or 3d4 damage to an individual. A being must also save against *Breath Weapon* or be *confused* (as the fourth-level wizard spell) for 12 rounds.

Each such sword has several show gems (i.e., gemstones that are only decorative, although they may be very valuable), but it may have one, two, or three power stones. These blue-green gems, of unknown origin, are able to hold magical energies within them. Identifiable by their cut, they can hold the following spells:

Cabochon: *regenerate* when grasped and ordered, as the seventh-level priest spell, but affecting only one creature touching the blade (up to 7 charges);

Crown-cut: *lightning bolt* from the tip of the blade, as the third-level wizard spell, with a range of 222' and dealing 7d6 damage (up to 3 charges);

Square-cut: *teleport without error* when grasped and ordered (affecting the sword-wielder and up to two other beings of medium size or less, or one large size being plus the wielder, who also touch the blade at the time) from some place to another

solid object of known location within a sphere, but not from one sphere to another (up to four charges).

Each charge equals one spell, called forth by mental command of the wielder, who is always aware of what the sword can do, in rough physical terms, and how many charges it has (magical ability not needed).

Recharging such swords is known to involve the casting of the spells they hold, but the process (and associated spells) remain secret. PCs will have to research their own (DMs may also wish to devise other gemcut/spell combinations).

XP Value: Unknown (method of making not discernible to PCs)

Helm-Bomb: The Arcane sell a very few *helm-bombs* typically at a cost of 40,000 gp or more. These large, not-easily-concealed devices are simply normal-looking helms that can somehow 'turn on' within the spelljamming field of another, magical power source.

In this rare instance of operating multiple power sources, the ship upon which the *helm-bomb* is placed is torn apart.

This occurs even if the controller of the original power source attempts to mesh the directions and intensities of the thrusts exactly. The devices' warring power fields force them apart, destroying the ship and firing the two sources away from each other in random directions and speeds. They continue to operate until power is removed or exhausted.

In the case of the original power source, that may be within a round. If it is a helm, the spelljammer suffers 2d4 hit points of damage while his helm smashes its way out of the ship, and must save against Death Magic or go into immediate 'Spelljammer Shock' (as detailed in the SPELLJAMMER™ boxed set rules). If this knocks the spelljammer out, the helm will cease to spelljam, although it will probably be well away from its

parent ship by then, and moving away, fast.

The *helm-bomb* rushes on through space, a dwindling but dangerous space missile, consuming its own material for power. It cannot be stopped or salvaged. The *bomb* typically consumes itself in 50 minus (ship's tonnage) days (a shipless *bomb* has a 1/4 ton weight). Ships over 50 tons use up the *bomb* in 1 to 4 turns.

A *helm-bomb* must be brought onto a ship (though it need not be fastened down or even taken into an interior area). If it is turned on when no other magical power source is "on," it does nothing except act as a self-powered helm that eats itself up and then collapses, doing 1-6 hull points of damage (and 1-6 points of damage per round to anyone sitting upon it as it operates).

Its bomb effects occur only when another power source is operating. If the *bomb* is already "on," a second source cannot be activated, and no ship breakup can occur. This way, it can be used as a one-shot 'hijack' power source, to prevent control by the ship's legitimate helm.

Activating a *helm-bomb* as a power source requires that a living being sit in the helm. The being need not have magical or spelljamming ability, but must sit there to will the helm into action. Such a being can get up as soon as he sets a course direction, and thereby avoid any damage as the *helm-bomb* consumes itself. However, if used as a bomb, the activator is on it when it flies apart and suffers the same 2d4 points of damage as a helmsman aboard the legitimate helm. An adroit activator can hurl himself clear an instant after engaging the *bomb*, to avoid being pulled out of the ship, but cannot avoid suffering damage.

Note that this provides a kamikaze (or at the least, very dangerous) method for intruders to damage, destroy or steal enemy ships in close-quarters combat. It also provides a

DM with some fast-moving Space Missiles (q.v.).

XP Value: Unknown (method of making not discernible to PCs).

Orb of Remote Action: This rare and useful magical spacefaring gear consists of a metal sphere bristling with telescoping, flexible metal legs mounted on swivel joints so that each can twist and turn freely.

The legs are control arms. Each is magically linked to an oval metal disc, which may be worn, swallowed, or otherwise affixed to any object, living or not. The manner of attachment will not affect the function of the device in any way, but each control arm can have one, and only one, specific disc linked to it when the item is created. If a disc is destroyed, its matching control arm is rendered useless.

An *orb of remote action* has 1d12 arms. Each can manipulate floating objects in wildspace, atmospheres, or phlogiston by means of their linkage with the discs affixed to such objects. Pulling a rod out to its greatest extent (about two feet) moves a disc away from the control orb; pushing it in flush with the orb will bring it within an actual foot of the control sphere. Bending a rod, or moving it in one direction or another, will cause a corresponding movement of the distant disc.

Control rods can become entangled all too easily, and there is a limit to the orb's effective range. A disc which drifts or is carried beyond 2,000' from an orb ceases to be controlled until it re-enters the orb's range. *Dispel magic* cast on a disc causes it to drop out of the orb's control for 2-5 rounds. The orb cannot push a disc in opposition to a concerted effort against it, nor can it cause disc-linked objects to pass through ship bulkheads, or strike obstacles with enough force to cause damage.

The device is normally used to help free-floating crewmen easily re-

pair or manipulate sails and rigging in deep space, or to retrieve lost and drifting objects. A ship can even be painted, or contact-weapons (such as heated metal spheres) brought against flow barnacles or other monsters on or near a ship's hull.

The device is not affected by the presence of magic or spellcasting, but the discs and the objects they move are subject to all physical and magical attacks in the normal way. A disc can move any object, regardless of shape or size, at up to MV 26 in a round, but whenever the object comes within two feet of any other solid object, it will suddenly slow (akin to the slowing of a spelljammed ship). This appears to be a natural space phenomenon, and occurs despite the wishes of the orb's operator.

An orb's control links will pass through any known physical or magical barriers, except a crystal sphere. That does not mean that an operator will be able to know what is happening to manipulated objects, nor does it mean that those objects can freely pass through such barriers.

The device can be used to create sparks or flames (by striking flint and steel, for example) at a distance in phlogiston, the only safe known means of doing so.

The control orb saves as metal, with a +4 bonus due to its inherent magic. Each disc saves as metal, with a +1 bonus. To activate it, an intelligent individual (that is, any being with an intelligence of 5 or more, who can manipulate the control arms) touches the orb and releases it. The orb will then float, levitating, in the position it was released in. If later moved, its movement affects all of the discs it controls. An orb may operate for 6-25 (5 + d20) turns in every 100 turns (the range represents a mysterious variance in the power of the device). When exhausted, its control links simply fail, and the orb sinks slowly down to rest on any surface (if within a gravitational field).

These orbs are thought to have

been fashioned by an ancient, now-vanished spacefaring race. They are few, and highly prized—not even the Arcane have a means of constructing or repairing them.

(An orb of remote action can have a great effect on close-quarters melee combat. Take care that its use does not overbalance play, by limiting its functioning or reliability whenever one PC or NPC seems to be misusing its powers, or when its use renders opponents helpless under the rules).

XP Value: Unknown (method of making not discernible to PCs)

Rod of Death: This rod may be fashioned of black obsidian or of human bone. The secrets of its making are known to few, and so it is thankfully rare. The rod must touch a being with a successful attack roll in order to function, and operates only when the wielder silently wills it to work. The wielder is immune to the rod's effects while holding it, and for 2-5 rounds after releasing it (even if another being directs the rod against its former wielder).

A rod of death may animate dead (as the third-level priest spell). The undead rise on the next round to loyally serve the rod's wielder. This function drains 3 charges.

The rod can also *disrupt undead*, destroying such undead forever.

An undead target need not be in solid form to be affected, and is destroyed despite phylacteries or other aids and properties that usually permit it to rise again (such as a vampire's coffin of soil). All undead are allowed a saving throw to gain immunity to the *disruption* attack of a particular rod of death. An undead saves vs. Rods as a wizard of the same level as it has hit dice. Undead disruption drains 2 charges, whether successful or not.

A rod of death may also cause death by touch. This power does not require a successful attack roll if the target is unmoving, and is effective only against beings that currently

have less than half their total hit points remaining. The touched being must save vs. Death Magic. If successful, the rod does them 2d6 damage. If the save fails, they are instantly slain (and may, if touched again on the next round, be animated as undead). Use of the rod in this manner drains 5 charges, regardless of whether the victim is slain.

The wielder of the rod can also will it to cause creatures to collapse. At the touch of the rod, the victim loses 1 hit point and must save against Rod at -3 or fall to the ground, apparently lifeless. This state lasts a minimum of 3 rounds, despite any attempts to revive the victim or *dispel magic*. This attack drains 1 charge each time it is used, whether successful or not.

A rod of death can also cause plants to wither and shrivel upon touch, losing blooms or spores. This does not kill the plants, and the rod cannot animate dead plant material.

XP Value: 7,500

Rod of Orbs: The secrets of making this rare rod are now lost. Some believe they are relics of vanished human spacefaring races. Others think they were devised by the Arcane, to prevail in early conflicts with beholders. Several archmages are known to be researching a means to recharge them; if any have succeeded in doing so, their achievement remains a secret. Such rods crumble instantly to dust when drained.

A rod of orbs is easily told from most other rods. Fashioned of brass or bronze, it has two bulbous, eye-shaped ends. When grasped, such a rod gives the holder 90' range infra-vision (draining no charges).

Once per turn, the bearer can mentally command the rod to give him *x-ray vision* (as the magical ring) for a continuous four-round period. The power can be ended earlier if the rod-wielder wills, but unused time cannot be saved for later or used in a succes-

sion of shorter amounts. This drains 1 charge per activation.

Once per day (i.e., a 144-turn period), the rod can be willed to give the wielder an indivisible, continuous period of *true seeing* (as per the fifth-level priest spell, save that the rod gives no vision into Ethereal or adjacent planes). This function drains 2 charges.

The rod also confers immunity to all gaze-related attacks (such as those of the beholder, catoblepas, medusa, umber hulk, and vampire), at a cost of 1 charge per attack. The rod must be held to confer such protection, but need not be wielded. When in such a state, the holder is automatically protected—and may not even be aware that a particular attack has been made (if such a rod is not held, its protection is not used, and no charges are lost to gaze-related attacks of any sort).

The wielder can will the rod to provide *reflection*, which costs 2 charges per attack protected against, instead of one. Unlike a *gaze reflection* spell, the rod's protection and reflection work against all forms of eye-related attacks, including the passive sort (e.g., medusa, umber hulk), the powers of magical items such as *cusps*, *eyes*, and *orbs*, and magical powers that are released from living orbs, such as a beholder's eyes.

Most *rods of orbs* have about 30 charges when found, but some have been known to possess 60 or 70.

XP Value: Unknown (method of making not discernible to PCs)

Gnomoi Gear

Spacefaring gnomes have invented much strange and outlandish gear, apparatuses, and weaponry for use in space. Some of it even works!

Globe Guns: Gnomes have been known to fire Greek fire, black puddings, ochre jelly, and grey oozes at opponents in readily-breakable glass

globes using globe guns mounted on their ship decks. Globe guns are ballistas that fire glass balls glued to ballista bolts. These suffer a 1- hex range loss over normal ballistas, and do half the standard physical impact damage (from glass shards and the carrier bolt) plus the effects of the globe cargo.

Spark Darts: These long wooden darts are fired by ballistas or even hand-held heavy crossbows. They have match-like heads (i.e., coated with a saltpeter-and-phosphorus mix, like a strike-anywhere match).

When a *spark dart* strikes a target, a flame occurs. Two in ten darts are duds, and never ignite. There is no way to test a dart before firing: once ignited, its flammable coating flares up and is consumed. Roll 1d10 for each hit to see if ignition occurs.

In wildspace, the flame of a *spark dart* causes 1d4 damage to any creature struck, and ignites all flammables (the DM may allow item saving throws against "magical fire" to avoid such conflagrations).

In planetary atmospheres, effects are identical to wildspace, except that damage is 1d6. Such darts are often used to attack flammable ammunition and/or targets, like sails.

In phlogiston, however, a *spark dart* strike causes a 3d6 fireball of 10' radius, centered on the dart.

In all cases, a striking dart is consumed. A creature struck by such a dart receives no saving throw to lessen flame damage, and also suffers normal dart damage (1d3).

Spell Reflectors: A few gnome ships are equipped with these rare Arcane-built devices (listed here because the Arcane seem to sell them only to gnomes—for unknown prices. Yet other races have seized them from gnome ships over the years.

A *spell reflector* is an ovoid chunk of apparently solid, dull metal, resembling pewter. It is always four



feet long by about two feet across, and weighs one ton.

A *spell reflector* reflects 100% of all spells, or magical item or artifact discharges within or entering its area of effect back on the source. The area of effect includes the host ship and the surrounding area within 20' of any part of the ship. This may cause damage to the caster/wielder or other beings nearby, or simply cause the magic to be expended but have no effect. The DM should judge each situation as he does the use of a *ring of spell turning*.

These items are unreliable; whenever magic contacts them, they have only a 2 in 6 chance of functioning. If they do function, half the time the magic effect is nullified, twisted (as a *wand of wonder* does) into some other result, or directed at a random being or object (including those it was intended to protect).

Multiple spell effects or magical item discharges may contact with a *spell reflector* in a given round. It can handle all of them, without limit, but

affects each differently.

A *spell reflector* penalizes a Ship's Rating by 1 (to the minimum; it cannot cause a ship to lose its SR entirely), as it hampers the magical power field generated by the ship's motive power. It does not inflict pain or discomfort on helm operators, although they will be constantly aware of its presence.

Attempts to shatter, melt, or break off any of the metal will cause an explosion that does 8d12 damage (and 2d12 hull point damage) to all beings and objects a within 20' spherical radius, utterly destroying the *reflector* in the explosion.

Scraping attempts (such as hitting the *reflector* with an edged weapon) have no effect on the device.

XP Value: Unknown (method of making not discernible to PCs)

Supersweepers: These are improved versions of the typical gnome sweeper (two ballista bolts linked with chain, and fired together). Sold only to gnomes, they consist of magically-electrified bolas, which gnomes hurl or fire across the decks of enemy ships, to break things and sweep away defenders.

On contact with a creature, a *supersweeper* does 2d6 electrical discharge damage, plus 2d4 physical damage. The statistics of these weapons are otherwise identical to a typical gnome sweeper as given in the SPELLJAMMER™ boxed set.

Usually linked iron or stone balls attached to a central hoop of thick steel by massive steel chains, *supersweepers* may or may not be spiked for extra damage (2d6 damage rather than 2d4), or have blades thrust through them for 2d8 dmg. The weapon's central hoop is affixed to a ballista shaft, which may be fired from *any* ballista weapon.

The magical means by which these weapons (and certain features of some gnome ships, such as railings and rams) are briefly electrified is one of the remaining, jealously

guarded, gnome secrets.

Giff particularly admire *supersweepers*, and sometimes go raiding entirely in order to capture these for their own use.

Supersweepers can be fired or hurled by crewmen, and have effective range of either one hex or about 70 feet, respectively. Beyond this, they always tangle themselves up and break into small, harmless fragments, an arcing cloud of tiny lightnings. This sometimes (2 in 6 chance) happens when they are fired or thrown. If fired, they deal the ballista itself 3 points of damage, and jam it for 1-2 rounds. If thrown, the hurling crewman suffers 2d6 electrical damage and (if surviving) is stunned for 2-5 rounds. Other crew touching the ballista or crewman will suffer half this stated damage.

If fired in the flow, *supersweepers* cause immediate spark dart effects (see above) *before* they leave the firing ship!

XP Value: Unknown (method of making not discernible to PCs)

Tangle Line Guns: Gnome ships often have deck-mounted line guns that fire tangle lines, lines coated with a sticky, flypaper-like glue solution, kept moist within waxed paper sleeves that are stripped off as the line is fired out.

Rules governing Fired Lines are given in the "New Rules" section of this sourcebook. Gnome *tangle line guns* work properly about a third of the time. Whenever one is fired, roll a d12; on a 5 or less, the gun jams and no line is fired (jammed guns of this sort are a major clean-up job). A jammed gun may entangle gear and beings within 20' in any direction (beings can free themselves in 1d2 rounds), and will typically take 1d8+4 turns of concerted effort by two crewmen to clear and be made ready to fire again.

Only gnomes are foolish enough to use such weapons in combat (although other races have been known

to trail the sticky lines behind them in debris fields, to pick up space plants, valuable flotsam, and captive beings for slaves or food).

Gnomes new to space often stagger around their decks under the weight of portable (i.e., unmounted, not lighter or smaller!) *tangle line guns*, thinking that this will give them better accuracy. It doesn't.

If they do manage to hit anything, they find themselves snatched off the deck as their ship moves one way, and the struck target another. Most forget to let go of the gun and end up being towed through space by whatever they hit.

Some gnomes are bright enough to use such guns to board other ships, but most who do so then try to run or climb along the sticky lines, becoming hopelessly entangled.

More successful gnome captains merely attach their ships to an enemy vessel by means of many tangle lines, and then pepper their foes with whatever weapons they have, or improvise thrown missiles, until the infuriated enemy tries to board the gnome vessel—and runs straight into all the traps and treacheries of a gnome-built ship (like collapsing quarter-decks, too-low top door sills, greasy steps and dreaded "labor-saving devices").

Water Cannons: Some gnome ships carry water cannons—one-hex-range wonders that drench everyone and everything with either precious drinking water, or (more often) with bilge- and waste-water, typically firing three to five one-round bursts before running out of 'ammunition.'

Such bursts batter gear and crew off their feet, requiring saving throws for the items and forcing Dexterity checks on the beings (failure equals a bad fall and 1d2 damage), and can ruin or prevent spellcasting and missile fire in the round of their firing.

A burst can also dampen or put out shipboard fires. The DM should judge such situations on a case-by-

case basis, taking into account the liquids used, gunnery skill, and the intensity and location of the fire. For dousing flames, a water cannon's output is equivalent to the work of eight fire fighting beings.

Living Things

This sourcebook lacks the space to identify and describe the many thousands of plants and other living things that have proven useful for medicinal and other purposes throughout spacefaring history. Some of the most important (and useful!) things are mentioned here.

Airslugs

These are tiny, harmless, jelly-like creatures native to space, resembling the slugs found on many worlds. They can exist in any sort of atmosphere or no atmosphere, but feed on bacteria and other motes found in atmospheric gases, and absorb light energy to sustain themselves. Found in groups in both the flow and wildspace, they can be readily captured (if one has a fairly airtight container).

Their chief use for spacefarers is that they change color from translucent pale pink, green, or blue to an ugly opaque reddish-brown when they encounter deadly air, and darken noticeably when they go from clean air to fouled air. They can thus be used to test atmospheres (a skimming ship exchanges 10% of its air per round).

Glowmoss

This harmless moss is found throughout space. Used as a component in several light-related spells developed by a variety of races, glowmoss is *very* important to spacegoing dwarves, who use it to light their subterranean tunnels.

Glowmoss produces a phospho-

rescent glow *and* fresh air as it feeds on stone and gases like carbon dioxide. Over time, glowmoss leeches certain minerals from stone, causing it to crumble away. The dislodged glowmoss will fasten onto more stone where it lands, drift on breezes to a new location, or 'crawl' toward the nearest rock to reattach itself.

Eating glowmoss or applying it to open wounds has been known to reduce infections and diseases, although the precise effectiveness of this varies (i.e., the DM is free to rule as he sees fit; note that glowmoss does *not* heal hp damage). It is known to be effective against the rotting disease of undead mummies.

If proficiencies are used in a campaign, glowmoss enables a character proficient in Healing to automatically check the progress of all diseases for 1-2 days, reducing such diseases to their lowest possible damage and debilitating effects. Note that this includes magical diseases. Using glowmoss, a character proficient in Healing, but lacking Herbalism proficiency can help a disease sufferer recover 3 hit points per day (from disease damage, not from other wounds or causes).

Glowmoss is ineffective against most poisons. In the hands of a character with Healing proficiency only, glowmoss will allow a poisoned individual a second saving throw against poison while under the healer's care (if the first has failed). It does not add any bonus or benefit to this second saving throw.

Lamp oil, acid, alcohol, or fire kill glowmoss, doing damage identical to the damage such substances do to humans (consider alcohol to equal acid). Damaged glowmoss goes dull as it regenerates (1 hp per turn, if light and air are present), brightening visibly as it 'heals.'

Only the presence of nutrient-rich water, mineral-rich stone, and abundant light together causes glowmoss to grow and expand with any rapidity. The maximum rate of growth is 1 hp

per 3 rounds.

A typical hand-sized clump of glowmoss gives enough light to read by within a 5' radius, and has 4 hp. Larger or smaller clumps will vary in hp and light intensity accordingly.

Starshine

Starshine is a phosphorescent lichen which grows everywhere in wildspace that light and something organic to grow upon can both be found. It's harmless, tasteless, and poor nourishment for human and demi-human spacefarers, but is handy as a light-source (it will glow with a *faerie fire*-like radiance even in total darkness, for 2d12 days). Where glowmoss needs rock, starshine prefers wood, plant leaves or other organic substances.

It is not known to harm beings that it grows on, and some experienced human spacefarers prefer to let some grow on a balding patch or a hand—so that removing a hat or glove gives one instant light. Spacefarers make unkind remarks about 'glowheads,' naming them dull-witted or crazy.

Starshine's name comes from the blue-white or pearly-silver hue of its radiance.

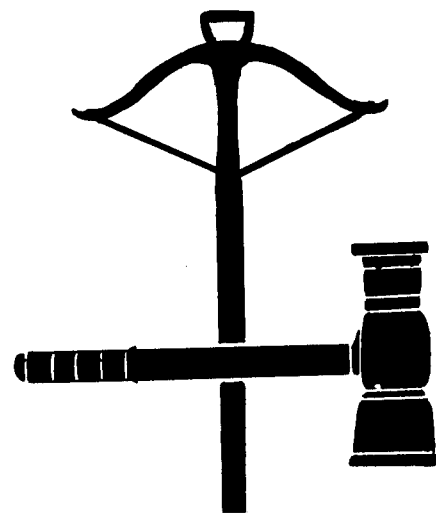

Beholder, Undead "Death Tyrant"

SJR1



CLIMATE/TERRAIN:	Any space
FREQUENCY:	Uncommon
ORGANIZATION:	Solitary or cohort (guardian)
ACTIVITY CYCLE:	Any
DIET:	Nil
INTELLIGENCE:	Special
TREASURE:	Any (guardian)
ALIGNMENT:	Lawful evil

NO. APPEARING:	1-20
ARMOR CLASS:	0/2/7
MOVEMENT:	Fl 2 (C)
HIT DICE:	As in life: 45-75 hp
THACO:	As in life (11, 9, 7, or 5)
NO. OF ATTACKS:	1
DAMAGE/ATTACK:	2-8
SPECIAL ATTACKS:	Magic
SPECIAL DEFENSES:	Anti-magic ray
MAGIC RESISTANCE:	Undead immunities
SIZE:	M (4'-6' diameter)
MORALE:	Fanatic (18)
X.P. VALUE:	13,000

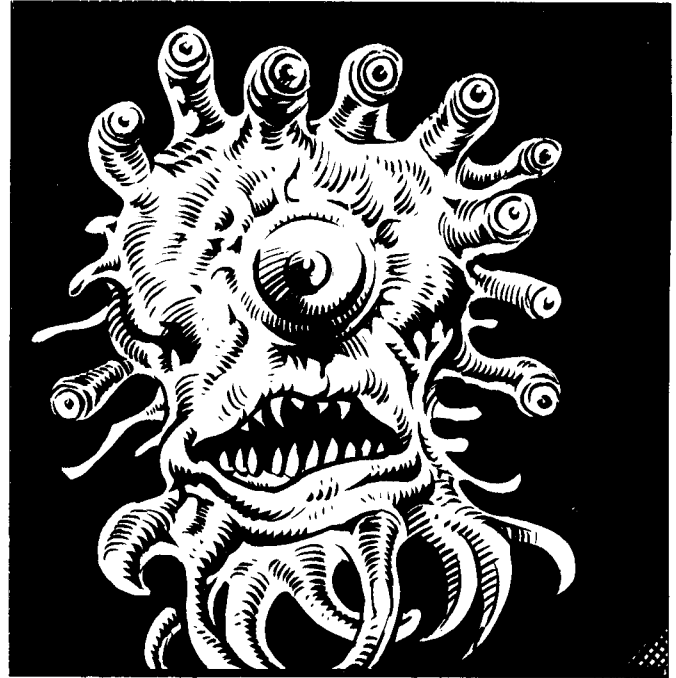

A type of beholder almost unknown on worlds is the undead beholder, or death tyrant.

Death tyrants are rotting, mold-encrusted beholders. They may be shrivelled or even have cavities that expose their bony skeletons of platelets attached to spherical networks of circular ribs. All sport wounds, some have eyestalks missing, and a milky film covers their eyes. They move and turn more slowly than living beholders, striking and bringing their eyes to bear last in any combat round.

Combat: An undead beholder can use all powers of surviving eyes just as it did in life. The powers of 2-5 eyes (select randomly, including the central eye) are lost due to injuries death, and the change to undeath. Although a death tyrant 'heals' its motive energies through time, it cannot regenerate lost eyestalks or their powers.

Beholder-eye *charm* powers are lost in undeath. The two eyes that charmed either become useless (60%), or function as weak *hold monster* effects (40%). A being failing to save against such a *hold* remains held as long as the eye's gaze remains steady on them. If the eye is turned on another being, or the victim hooded or forcibly removed, the *hold* lasts another 1-3 rounds.

If not controlled by another creature through magic, a death tyrant hangs motionless until its creator's instructions are fulfilled (e.g., "Attack all humans who enter this chamber until they are destroyed or flee. Do not leave the chamber."). If no instructions are given to a "new" death tyrant, it attacks all living things it perceives.

Death tyrants occur spontaneously in very rare instances. In most cases, they are created through the magic of evil beings—from human mages to illithid villains. Some out-cast, magic-using beholders have even been known to create death tyrants from their unfortunate brethren.

Habitat/Society: Death tyrants have no self-awareness or social interaction. Like orbi (see the description of the orbi in the SPELLJAMMER™ boxed set), they are mindless servants of living beholders. They will usually be found either abandoned (for example, in beholder ships or bases left ruined af-

ter a battle) or serving beholder society as guardians or unskilled workers.

'Mindless' is a relative term; the once highly intelligent brains of death tyrants still use their eyes skillfully to perceive and attack nearby foes. They are among the more intelligent undead; only the cunning and strategies they had in life are gone. When a death tyrant is controlled by another being, consider it to have the intelligence of its controller.

Ecology: Death tyrants are created from dying beholders, those condemned as traitors to their race (or sub-race; beholders belong to many warring clans), and captives taken in battle by beholders of another nation. A spell, thought to have been developed by human mages in the remote past, forces a beholder from a living to undead state, and imprints its brain with instructions.

A spell developed by spacefarers enables anyone having 15+ intelligence and natural or magical *charm* abilities (including a living beholder) to command obedience from a death tyrant. If such a spell is successful, the death tyrant will use its powers just as a *charmed* human obeys a wizard who cast the *charm*. Rumors of devices that create these control effects persist—as do tales of humans and liches who command death tyrant guards.

'Rogue' death tyrants also exist: those whose instructions specifically enable them to ignore all controlling attempts. These are immune to the control attempts of all other beings. Beholders often leave them as traps against rivals.

Human spell researchers report that control of a death tyrant is very difficult for humans. A beholder's mind fluctuates wildly in the amount and level of its mental activity, scrambling normal *charm monster* and *control undead* spells and variant magics developed from them. A special spell must be devised by any wizard desiring to command a death tyrant.

Although the eyestalks, brain, and levitation powers of a death tyrant still function, alchemists and wizards report that they disintegrate when the creatures are destroyed.

Beholder Eater, Thagar ("Grimgobbler") SJR1



CLIMATE/TERRAIN: Any space
FREQUENCY: Rare
ORGANIZATION: Solitary
ACTIVITY CYCLE: Any
DIET: Carnivore
INTELLIGENCE: Exceptional (15-16)
TREASURE: Nil
ALIGNMENT: Chaotic neutral

NO. APPEARING: 1
ARMOR CLASS: 1/4/6
MOVEMENT: Fl 12 (B)
HIT DICE: 9+9
THACO: 11
NO. OF ATTACKS: 6-16
DAMAGE/ATTACK: 2-8 per neck
SPECIAL ATTACKS: Nil
SPECIAL DEFENSES: Magical immunities
MAGIC RESISTANCE: 70%
SIZE: L (7' diameter, necks to 14' long)
MORALE: Fanatic (17-18)
X.P. VALUE: 9,000

The seldom-seen, near legendary thagar are fearsome predators, voracious eaters whose favorite meal is beholder flesh. Eye tyrants hate and fear them—for when thagar and beholder meet, it is rare for the beholder to escape, let alone emerge victorious.

Thagar are large, rubbery-skinned, dark-hued spheres from which protrude long, serpentine necks ending in many-toothed jaws.

A thagar's eyes stud its central body amid the twisting necks. Thagar levitate slowly about, cruising space in search of meals or devising elaborate trap-lairs to lure prey.

Combat: Thagar are immune to many spells and spell-like magical attacks with a high natural resistance to other magics.

Thagar are immune to *charm*, *sleep*, *hold*, *fear*, *confusion*, *feeblemind*, and other mind-related magics. They are 96% magic resistant to magical effects that change their body state, including all *polymorph*, *petrification*, and *disintegrate* attacks. They possess 120'-range infravision.

A thagar waits patiently for the right moment to attack, then charges in furiously, seeking to disable as many creatures as it can, concentrating on spellcasters and other obvious menaces, never pausing for parley or to catch a breath.

Thagar instinctively try to devour eyestalks, or the eyes and limbs of *any* opponent. They anticipate traps and attacks, often using their bulk to pin one opponent while battling another, only to spurt aside in haste and let the pinned victim take the brunt of a spell or missile attack.

The body of a thagar is AC 6 and its writhing necks and mouths are AC4. The many eyes of a thagar (a typical specimen has over 20) are small and hard to hit, located between the bases of the coiling necks. Each is a deep purple, flat, glistening orb the size of a human fist, surrounded by a crater-like rim of protective bone, and having an effective AC of 1.

A thagar begins life with 2d6+4 mouths and may lose some over the years (while lost hp heal at the normal rate, lost necks and mouths regenerate slowly, typically only one per year).

Healing necks are usually kept curled close to the body and often glisten with a protective slime exuded by a thagar's

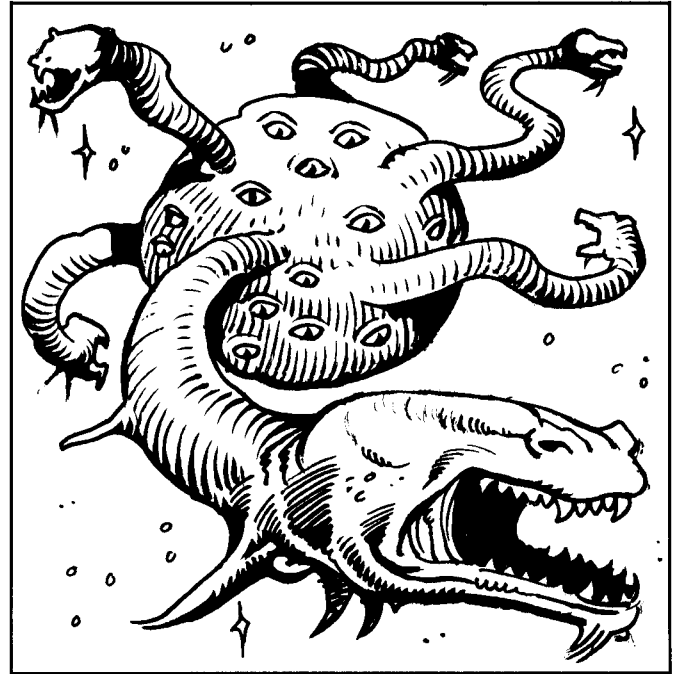

other mouths. A thagar who loses all its mouths will die of starvation.

Habitat/Society: Thagar like to lair in derelict ships, asteroid caverns, and debris fields. Bisexual, they meet with others of their kind only to mate, about every dozen years or so. The young are born live and left to fend for themselves (they are the much smaller thagars sometimes found in desolate areas on worlds).

Thagar are unaffected by cold or lack of air. They take in nutrients from atmospheres around them, but need not do so, and will close their intake pores when they suspect poisonous or harmful substances or when expecting attack.

Thagar often cooperate with servant creatures that they can control completely, using these to aid in setting up traps, for defense, as bait, and as a food supply when times are hard. Thagar will eat carrion if they must, but they prefer the flesh of magic-using creatures, particularly beholders. They can go for long periods without food, but seem to have no limits when food is available; one sage reported seeing a thagar on a battlefield eat literally all day and into the night, devouring almost 1,000 men before it became too dark to see—or remain so close.

Ecology: Thagar are one of the few natural predators of beholders, and also control the numbers of other large and powerful creatures that might otherwise rule space. They keep the radiant dragon population low, for instance, by preying on young who have strayed from their elders. Thagar-flesh itself is oily and unpleasant, and eaten by few creatures besides scavvers.

Neogi detest thagar and hunt them on sight—thagar eat umber hulks (another delicacy), depriving neogi of slaves and status.

Thagar float by means of a magical organ which generates the natural ability of *levitation* (a living thagar cannot be robbed of this ability by *dispel magic* or other magical attacks). This organ is valued by alchemists and wizards alike for use in spell ink formulae, and in the making of potions and magical items concerned with levitation.

Flow Barnacle

SJR1



CLIMATE/TERRAIN:	Phlogiston, wildspace, drifting, or on ships and other solid bodies
FREQUENCY:	Uncommon (rare in wildspace)
ORGANIZATION:	Clumps
ACTIVITY CYCLE:	Any
DIET:	Omnivore
INTELLIGENCE:	Non (0)
TREASURE:	Nil
ALIGNMENT:	Nil

NO. APPEARING:	2-40 (2d20)
ARMOR CLASS:	4
MOVEMENT:	Fl 16 (D)
HIT DICE:	1
THACO:	19
NO. OF ATTACKS:	1
DAMAGE/ATTACK:	6
SPECIAL ATTACKS:	Grip, 1 hp/round nutrient drain
SPECIAL DEFENSES:	Nil
MAGIC RESISTANCE:	Nil
SIZE:	T (8"-2' overall length)
MORALE:	Nil (treat as "Fearless" = 20)
X.P. VALUE:	35

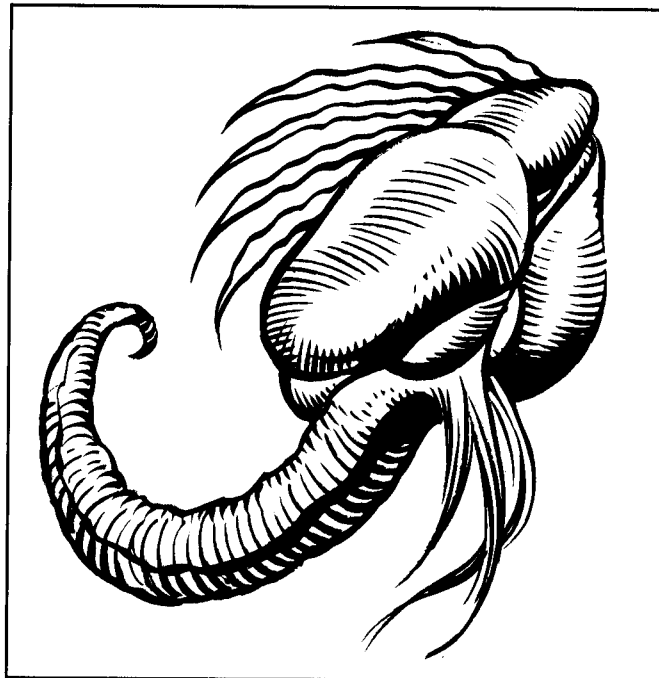

So named because they are primarily encountered in phlogiston, these hard-shelled, unintelligent creatures fasten themselves limpet-like to the surface of any object they encounter—be it ship, rogue planetoid, or drifting being, and slowly eat into it.

Flow barnacles look very much like immature krajen (detailed in the SPELLJAMMER™ boxed set), but the two are not related. They also resemble planetbound, aquatic limpets and barnacles, but are usually at least the size of a human head. Spacefarers who see bone-colored triangular points protruding from their ship's hull where there was nothing before are warned that they have a flow barnacle—or 40—aboard. Flow barnacles are ivory or orange, often pinkish when young or wounded. When near death, they turn brown or black.

Combat: Flow barnacles will eat metal and organic matter alike—a menace to ships, valuables stored in chests, drifting characters encased in softwood, and to a lesser extent all spacefaring beings. They are neither agile nor cunning, but simply drift into characters, or convulse their bodies to expel a jet of captured atmosphere or moisture, and 'spurt' their way (at the listed movement rate) toward the nearest living thing.

If they hit, they will adhere with an almost-unbreakable grip and extend three parrot-like beaklets, which bite for 2 hp of damage each. They will then suck a further 1 hp of nutrients (e.g., bloodborne) each, per round until the prey's body is exhausted or the barnacle is detached.

A flow barnacle can be readily detached when dead. Removing a live barnacle requires a total strength application of 33 (i.e., several beings working together) for 1 round, and causes 2-5 points of damage to the barnacle's victim as it tears free.

Habitat/Society: Flow barnacles drift mindlessly in space and attach themselves to anything solid they encounter. They exist only to eat, straining all passing organic matter

with their sticky feelers and absorbing available moisture and starlight.

When sufficiently nourished, flow barnacles develop an internal egg-sac of miniature, soft-shelled young. In conditions of warmth, moisture, and starlight, these are released into space.

Flow barnacles dislike excessive heat, light, or air (only excessive heat harms them in the same manner as humans are harmed) and tend to avoid all types of worlds.

Ecology: Some spacefaring creatures (including starving adventurers) eat flow barnacles, shattering their shells to get at the meaty, muscled body and foot underneath. Flow barnacles are said to be rubbery, and somewhat like poultry or squid in taste. Some humans are violently allergic to the flesh of flow barnacles (treat effects as a mild poison).

One in four flow barnacles form large, perfectly-shaped blue-white pearls ("moonpearls") within their glistening black, slimy amorphous inner bodies. They do this when an irritant piece of debris enters through their feeler hole. Each barnacle forms only a single pearl in its lifetime. The pearls take 2-8 years to form, and range in size from about the size of a man's thumb to about the size of a man's closed fist. They are very valuable (1,000 - 5,000 gp, depending on size, shape, and hue).

The hard, protective body-plates of flow barnacles are usable as shields and bucklers. The feeler-hole in the center is ideal for use as a mounting for a dagger-point, or as a firing-port for a wheel-lock barrel (the plates are often permanently fixed to such weapons by giff and human pirates).

Magical *sovereign glue* is partially derived from distilled flow barnacle essence.

CLIMATE/TERRAIN:	Any
FREQUENCY:	Very rare
ORGANIZATION:	Solitary
ACTIVITY CYCLE:	Any
DIET:	Nil
INTELLIGENCE:	Supra-genius (19-20)
TREASURE:	A, T, V
ALIGNMENT:	Any good

NO. APPEARING:	1
ARMOR CLASS:	0
MOVEMENT:	6
HIT DICE:	11+
THACO:	10
NO. OF ATTACKS:	1
DAMAGE/ATTACK:	1-10
SPECIAL ATTACKS:	See below
SPECIAL DEFENSES:	+1 or better magical weapon to hit
MAGIC RESISTANCE:	Nil
SIZE:	M (6' tall)
MORALE:	Fanatic (17-18)
X.P. VALUE:	9,000

Archliches are a *very rare* form of undead. They are transformed human spellcasters of *good* alignment who have deliberately and carefully accomplished their own transformation into undeath. These caring individuals do so to serve a cause or protect a loved being or place, and devote their undeath to the furtherance of their purpose.

Nevertheless, archliches resemble lichs. They appear as gaunt, skeletal humans who radiate a menacing chill, and wear tattered, once-fine robes (25% of which are magical).

Their eyesockets contain only twinkling lights; magical eyes that are unaffected by light, but can see in the deepest darkness as keenly as they saw in normal light, in life. Archliches were formerly wizards or priests of at least 18th level, or bards of at least 24th level.

Combat: Archliches like to avoid direct combat if possible. Unlike lichs, they are immune to clerical turning or disruption. Their strength of will combined with the process through which they attain lichdom renders archliches immune to all mental magic (*enchantment/charm* and *illusion* spells and effects). They can therefore never be magically controlled or influenced by another being.

Archliches exude an aura of power that causes creatures of less than 5 hit dice or 5th level to flee in terror for 4d4 rounds. Their touch chills living things for 1-10 hit points of damage, and causes instant *paralysis* to victims that fail their saving throws. Such paralysis lasts 2-5 turns, unless magically *dispelled*.

An archlich can, by touch and will, *repel undead*—this power compelling even the most powerful undead creatures. Archliches are themselves immune to poison, disease, and all energy- and ability-draining undead attacks.

An archlich can *animate dead* by touch and will, to raise skeletons and zombies to serve it. If it so wills, its touch can give it the same control over existing wights and lesser undead as it has over the undead it animates. Such things are usually done in battle. An archlich has no interest in raising armies to serve it, nor in controlling others by force or fear.

Archliches can be hit only by magical weapons of +1 or greater power, by magical spells and item effects, and by



monsters having 6 or more hit dice or levels, and/or magical properties.

Polymorph, paralysis, petrification, cold, electricity, death, and insanity-causing spells and effects have utterly no effect on an archlich. *Raise dead* and similar spells will do an archlich 1 hit point of damage per level of the being casting them.

An archlich is able to employ spells and magical items just as it did in life. It still requires the use of magical components, spellbooks, and the like—with nine exceptions (see below). Archlich bards retain their musical abilities. Many have composed haunting, melancholy ballads in their undeath, and are known to roam dungeons, ruins, and desolate moors or bogs at night playing and singing the tunes of the past.

Each archlich can choose nine spells that it knows at the time of achieving undeath, and retain them in memory. When each is later cast, it is forgotten, but regenerates spontaneously in the archlich's mind 144 turns later. Typically *dispel magic, fly, invisibility, teleport* and a few offensive spells are retained by archliches in this manner.

Habitat/Society: Unlike lichs, archliches have no phylacteries. They enshrine their life forces in a usable magical item (see below).

Archliches are usually solitary. They prefer to work behind the scenes, in study, contemplation, and (through servant creatures and allies) manipulation of other beings, to achieve their own ends. A few archliches exist to further their own mastery of magic, but most exist to serve a kingdom or royal family, a particular hero or organization, or to exact revenge or complete a goal left unfinished at death.

Archliches make their homes anywhere, but tend to conceal their presences or natures from living men, to avoid continual attack. They have the endless patience and cunning of their more evil counterparts, lichs, and can make deadly foes.

Archliches, unlike lichs, do not forget. This is both a blessing and a curse. They may grow very weary with the passing years and seek to end their own existence, but they never spurn their own names or former friends.

Lich, Arch

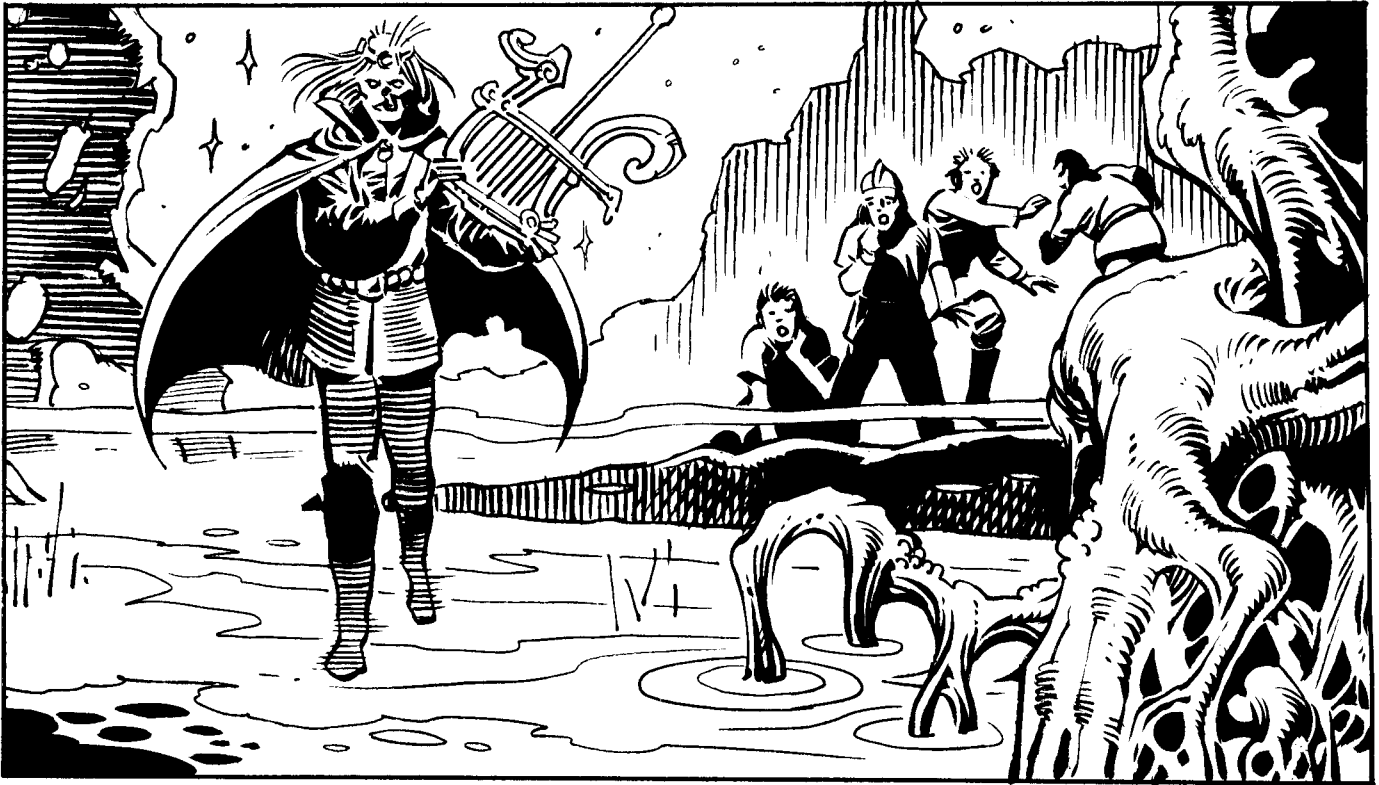

Archliches will often work with the living—rangers, bards, and wizards in particular—to achieve a common goal. Archliches have even been known to love living beings, tend the wounded, or tutor living wizards. However, they can never achieve true life again, short of divine means.

Knowing an archlich's name gives a creature no power over it, but archliches can hear their names spoken anywhere on the same plane, and sometimes (06% of the time) come curiously, to investigate.

Archliches can *water walk* (as the third-level priest spell) as a natural ability, at will. Those who live on islands or in marshes or rivers are often seen walking silently along where a living creature would plunge into the depths. Archliches always move silently unless they will themselves to do otherwise.

Ecology: To become an archlich, a living spellcaster must create a magical item of some sort. By tradition, for most wizards this item is a miniature spellbook into which they put the nine spells they seek to carry forever in undeath.

A potion must then be created and enchanted with the spells *animate dead*, *chill touch*, *contingency*, *pass without trace*, *permanency*, *teleport*, *trap the soul*, and *wraithform*. The would-be archlich drinks the potion while touching the chosen magical item, which must be anointed with at least one drop of the would-be archlich's blood.

A single, secret spell is then cast, and the being either dies (07% chance) or enters undeath (83% chance), collapsing into a death-like slumber that lasts 4-16 turns. When the being awakes, it will be an archlich forevermore.

The potion may be created and the lichdom spell cast by the would-be archlich or by another being; i.e., a prospective archlich may achieve undeath through the magical assist-

ance of another. The process cannot, however, work on an unwilling creature (its death will always result). The would-be archlich may also have aid in creating the magical item that stores its essence, but must take an active part in its creation.

Should an archlich be destroyed, whatever remains of it is instantly *teleported*, even across vast distances or many planes, to touch the magical item containing its essence. The archlich will then begin to slowly re-form, gaining 1 hp per day, until it is whole once again. Until it has regained at least one-quarter of its hit points, the archlich will be immobile, yet will be able to speak.

It will regain one of its nine spells per day until it has them all (and once regained, each will return again a day after being cast). The immobile lich can cast these spells while still otherwise helpless, and need not remain in the vicinity of its magical item to further recover.

Whenever this process occurs, whatever items the archlich is wearing or holding when slain come with it, but all memorized spells are lost.

If the archlich's magical item is physically destroyed, the archlich is also instantly and irrevocably destroyed. Merely exhausting the charges of such an item, or dispelling its magical powers, will not harm the archlich; destruction is required.

Archliches need not eat, drink, or breathe. Their bodies never change, sweat, blush, ache, or grow hair as those of living humans do. They can eat, drink, smoke, and so on if they wish to do so.

CLIMATE/TERRAIN:	Any space or city
FREQUENCY:	Rare
ORGANIZATION:	Solitary
ACTIVITY CYCLE:	Any
DIET:	Omnivore
INTELLIGENCE:	Varies: 11-18 (10 + 1d8)
TREASURE:	J,K,Q,S,V,X (A,B,H)
ALIGNMENT:	Any (usually chaotic neutral)

NO. APPEARING:	1
ARMOR CLASS:	Varies (10)
MOVEMENT:	12
HIT DICE:	Varies; usually 7-12 (6 + 1d6)
THACO:	Varies
NO. OF ATTACKS:	Varies
DAMAGE/ATTACK:	By weapon type (plus possible strength bonus)
SPECIAL ATTACKS:	Nil
SPECIAL DEFENSES:	Nil
MAGIC RESISTANCE:	Nil
SIZE:	M
MORALE:	Varies; usually Elite (13-14)
X.P. VALUE:	Varies



“Wonderseekers” are spacefaring humans who roam space in search of entertainment, conducting elaborate games among themselves in which other beings may become unwitting accomplices or pawns.

Wonderseekers are nothing like “Seekers,” who quest after knowledge. Rather, they are dilettantes, dabbling unpredictably in other’s lives and affairs for personal satisfaction alone. They may aid or inform others, or attack or torment them.

Wonderseekers favor frilly, fantastic garb, with cloaks, gems, and body adornments. They often carry magical *gemswords* (see “Personal & Ship Equipment”) and *wands of paralysis*. They use elaborate, courtly manners and flowery speech, and have a taste for wild adventure coupled with innate wanderlust.

Combat: Wonderseekers may appear bored and effete, but all are warriors (66%) or rogues (67-77% thief; 78-90% bard; 91-99% dual-classed, wizard and one of the classes already listed; 00% dual-classed and having an inherited spell-like innate magical natural ability).

Wonderseeker magical abilities are usually small-scale alterations of their own person. All are usable once per turn, but only 3-6 times in a day. The most common abilities are *dimension door*, *fly*, *invisibility*, *levitate*, *spider climb* and *telekinesis*. No wonderseeker ever has more than one ability. Such powers may be used on a whim or to escape danger, but are never advertised or revealed without reason.

Wonderseekers are proficient in the use of long swords and in a variety of other weapons, usually hand crossbows, throwing axes, darts, and daggers. If fighters, wonderseekers specialize in long sword use. They use wits and tongue to avoid needless combat—it’s messy and brings trouble with local authorities. Most pursue duelling as a hobby.

Habitat/Society: Wonderseekers are misfits who go their own ways to seek their own pleasures and achievements. Decadent and bored, most achieve satisfaction in fulfilling personal wants through sheer time, persistence, and devising or acquiring magical items. They feud among them-

selves, but also share mutual honor and respect—and will aid even hated rivals against neogi, illithids, and other monsters. They rarely duel another wonderseeker to the death—but instead favor “The Death of Seven,” a ritual in which one anonymously hires seven assassins to slay another.

Each assassin must work alone, making a single attack at least one day after a previous attempt. Each must leave a clue as to their sponsor’s identity (the sponsor devises and supplies these clues). The terms of the ritual stipulate that a wonderseeker can never try another Death of Seven against anyone surviving all seven attempts, and that the survivor should have received clear clues to know exactly who sponsored the Death against him.

To become a wonderseeker, one must have access to *potions of longevity*, find a way into space, and survive. Most are adroit traders, thieves, and explorers, and have acquired magical wands, potions, and such mundane but useful magical items as a *decanter of endless water* and a *Murlynd’s spoon*.

The DM must decide what magic a wonderseeker has hidden on his person, ship, and in treasure caches. A wonderseeker usually carries 2-5 personal magical items. Small, portable items are favored, especially those that can be worn or concealed. Popular items include *bracers of defense*, *lens of detection*, various *figurines of wondrous power*, and *necklaces of missiles*. Several specialize in making unique (DM-devised) forms of *Quaal’s feather tokens* to surprise and confound foes.

Wonderseekers often seem calm and uncaring in the face of great danger. Following them or their advice can be deadly; to them, entertainment is all. They always seek novelties and experiences, and battle all who would impose order on them or others.

Ecology: Wonderseekers are essentially gadflies and parasites. They serve as wild cards working unpredictably against other power groups, such as the Arcane, slavers, pirates, and all others who seek to rule by might or to impose authority. Many wonderseekers are invaluable to adventurers as allies, informants, hired rescuers, and fences of stolen property.

Neogi: Undead Old Master

SJR1



CLIMATE/TERRAIN:	Any space
FREQUENCY:	Very rare
ORGANIZATION:	Solitary
ACTIVITY CYCLE:	Any
DIET:	Nil (see below)
INTELLIGENCE:	Highly (13-14)
TREASURE:	Any
ALIGNMENT:	Lawful evil

NO. APPEARING:	1
ARMOR CLASS:	5
MOVEMENT:	3
HIT DICE:	7
THACO:	13
NO. OF ATTACKS:	3
DAMAGE/ATTACK:	1-3/1-3/1-6
SPECIAL ATTACKS:	Chill touch
SPECIAL DEFENSES:	See below
MAGIC RESISTANCE:	10%
SIZE:	S (3' high)
MORALE:	Elite (13-14)
X.P. VALUE:	3,000



Certain cunning, magic-using neogi who grow old resist their coming transformation into great old masters, and flee neogi society to achieve undeath through their magic.

Strong-willed and ruthless, such individuals transcend the limits of their living fellows and become fell, self-sufficient predators, preying on all weaker creatures.

Undead old masters are similar to living neogi: hairy, brightly-colored spiders with eel-like heads and necks. With time, their flesh shrivels, their pelts fade, and they exude a smell of carrion.

An undead old master's eyes are sockets lit by ghostly lights rather than the black, glistening orbs of living neogi. These "night neogi" (as they are sometimes called) are crafty, paranoid planners. They move slowly, but in spell use and anticipating enemies, they are very, *very* quick.

Undead old masters whose magic runs to illusions tend to disguise themselves to appear alive—grander than they ever were in life. One such disguise is shown on page 49 of the *Concordance of Arcane Space* in the SPELLJAMMER™ boxed set.

Combat: Undead old masters always move in utter silence, avoiding combat when possible. They use their spells without hesitation to lash out at foes, and can fight with their claws and teeth like their living fellows.

The undead state of these creatures causes them to stop producing poison. However, the touch of their claws and jawmandibles *chills* living targets in a similar way that the touch of a lich does.

Whenever an undead old master physically attacks, the victim suffers an additional 1-2 points of cold damage, and must save vs. Paralysis or remain motionless on the following round. This temporary "*hold*" lasts only a single round, but if the undead neogi strikes the victim again during that round, it must save again to avoid being *paralyzed* on the next round, and so on.

Their particular undead state renders undead old masters immune to *sleep*, *charm*, *fear*, *hold*, and *death* magics. They

are also immune to poison and paralysis effects. Attacks based on cold or electricity do them only half damage. Undead old masters are unaffected by diseases (although they can carry and transmit them) and insanity. They turn as "Special," and cannot be disrupted.

Undead old masters retain the spellcasting abilities they had in life, and in fact can increase them by study, practice, and the acquisition of new spells. Most encountered undead old masters are the equivalent of 8th-level wizards (to find an individual's level of spell use, roll 1d8 + 4).

Those who manage to retain the slaves they had in life do not lose them in attaining undeath. Most encountered undead old masters will have a bodyguard of 3d4 + 1 umber hulks (see the AD&D® *Monster Compendium*).

Habitat/Society: Undead old masters hate all other beings, including neogi. They trust nothing and no one, and exist only to gather slaves and treasure, and use these to acquire more slaves and treasure, controlling all they can. What they cannot control, they lust to destroy.

They tend to lair in dark, uninhabited caverns or ruins—or in space, aboard derelict ships.

Ecology: Undead neogi can devour things, but no longer need to eat, drink, or breathe, and can now see in the dark. They serve to weed out the weak and the servile in all societies near which they lurk, and on occasion may dominate and shape societies from behind the throne, controlling lesser beings by awe, fear, clever manipulation, and their magical powers.

Sarphardin (“Watcher”)

CLIMATE/TERRAIN:	Any space, very rarely worlds
FREQUENCY:	Rare
ORGANIZATION:	Solitary (telepathic clan links)
ACTIVITY CYCLE:	Any
DIET:	Gems and refined metals
INTELLIGENCE:	Supra-genius (20)
TREASURE:	V,T,X
ALIGNMENT:	Chaotic good

NO. APPEARING:	1 or 1-4
ARMOR CLASS:	5
MOVEMENT:	6, Fl 20 (A), Sw 18
HIT DICE:	8+8
THACO:	13
NO. OF ATTACKS:	2
DAMAGE/ATTACK:	2-12/2 per round/1-2
SPECIAL ATTACKS:	Spell use
SPECIAL DEFENSES:	Regeneration (see below)
MAGIC RESISTANCE:	36% plus intelligence-related spell immunities
SIZE:	H (16'-24' long)
MORALE:	Elite (15-16)
X.P. VALUE:	6,000



Sarphardin resemble nagas, with snakelike prehensile bodies and huge dragon-like reptilian heads. They are curious and whimsical in nature, and have the natural ability to travel through space by spelljamming (without helm or ship, although one can carry a ship of 20 tons or less with it, as long as it remains in direct physical contact with the vessel). Groups of sarphardin working together can move vessels of up to 100 tons through space. They cannot cooperate with *spelljamming helms* or other power sources to increase the SR of a ship, but can use any helm they touch as though they were human spellcasters.

This ability has made them very helpful to adventurers in need of rescue—and deadly pursuers when they hunt down and slay foes.

Sarphardin regenerate damage at the rate of 1 hit point every four rounds.

Combat: In battle, sarphardin use their strong jaws (2-12 dmg) to bite opponents, whom they entangle or slap (1-2 dmg, plus successful Strength Check or be knocked over; if drifting in space, sent tumbling head-over-heels).

A sarphardin is scaled, and its head is covered with bony plates and ridges (hence the more-agile body and the more-armored head share the same armor class).

A sarphardin can make an entangle attempt once per round by making a successful attack roll. Entangled targets can be hit automatically by all sarphardin attacks (bite and spell use). At the end of the first round of entanglement and every round thereafter, however, a target is allowed a Strength Check to break free. If it succeeds, freedom is gained, and only 1 point of constriction damage is suffered that round. If it fails, 2 points of constriction damage are suffered, and constriction continues.

In addition to its physical attacks, a sarphardin can cast one spell per round. The spell-power of a sarphardin is equal to that of a 7th-level wizard: four 1st-level, three 2nd-level, and two 3rd-level spells, and one 4th-level spell.

Sarphardin use verbal-only spells, which they largely acquire by using *invisibility* spells to spy on world-bound beings using spells, and bringing treasures to world-bound beings in

exchange for tutoring in a new, desired spell in verbal-only form. Sarphardin speak the common tongue and a hissing, purring language of their own.

Sarphardin can also use potions, scrolls, and all magical items allowed to both warriors (e.g., magic swords) and wizards (e.g., most wands) that they can hold in their prehensile tails and command verbally or by effort of will.

The high intelligence and wisdom of sarphardin renders them immune to *illusion* spells of 1st-3rd level, and to the spells *cause fear*, *command*, *forget*, *friends*, *hypnotism*, *ray of enfeeblement*, and *scare*. They are not “persons” for the purposes of *charm* and *hold* magics, but can be affected by the stronger “monster” versions of those spells.

Habitat/Society: Sarphardin are almost always encountered in space as solitary wanderers, watching others. Watching sarphardin will do nothing except cock their heads, bob and weave to see better, and emit a purring ‘mmm-hmmm’ noise. They will defend themselves if attacked, but often merely dodge ‘warning shots’ or hurled objects, and drift a little closer to watch with renewed interest.

Sarphardin are essentially passive. They approach life as an entertainment, and each sarphardin is determined to see the best ongoing show it can. Space-battles and large-scale disasters often attract a crowd of calmly-watching, floating sarphardin.

Sarphardin never fight others of their kind. They cannot be coerced or duped into doing so; illusions or magical controls will be shattered if an attempt is made, for a sarphardin can always tell another sarphardin, however disguised.

Sarphardin are bisexual, and give live birth to tiny, soft-scaled young. Mating and child-rearing take place in well-hidden enclaves in jungles on obscure worlds, or in deep caverns in rogue planets drifting in little-traveled areas of the flow. Sarphardin in these places will hide from or avoid intruders, using their magic to escape if necessary.

All sarphardin are ‘family;’ that is, all are members of a single clan, to which all sarphardin are intensely loyal. Sarphardin have in the past pretended to be willing to provide others of their kind to neogi and illithid slavers—but invariably the

Sarphardin (“Watcher”)



slavers (who planned to seize the bargaining sarphardin as well) have found themselves maneuvered into the ambush of an elven armada, or the midst of a beholder flotilla.

Of all the races of space, elvenkind have the closest dealings with sarphardin. Dwarves, gnomes, and humans are regarded as less trustworthy, but better (particularly the latter two races) at providing a sarphardin with entertainment.

Ecology: Sarphardin require little air, and can tolerate a wide variety of atmospheres, breathing fouled atmospheres as if they were clean, and deadly air as if it was merely foul. When spelljamming, they typically slow down to skim planetary atmospheres from time to time (If one is acting as the spelljamming figurehead of a ship, it will be considerate enough to choose an atmosphere breathable by those aboard the ship).

Sarphardin eat minerals, both gems and refined metals (such as coinage), and will always want to be paid to effect a rescue, spelljam a ship, or aid someone in battle (worth about 1,000 gp to a sarphardin, 3,000-4,000 gp, and 2,500-5,000, respectively).

Sarphardin prefer to bargain first, perform, then get payment in full—spelljamming a ship to a world where the captain and crew have money stashed to pay for the ‘jamming would be fine. Someone who declines to pay after reaching a bargain with a sarphardin will simply be ignored, forever after, by all sarphardin. They will not speak to, bargain with, or aid such an individual, and if the black-listed being is rescued with others, the fee will be at least 1,000 gp higher (in rare cases, this ban has been lifted after the transgressor has pleadingly and handsomely made amends—called “kissing the snake” in spacer lingo).

Sarphardin have a 2-mile-range telepathy with other

sarphardin. Others can join this communications network by exercise of natural power or by magic, but it occurs on a level where other telepathy is not usually found, and must be magically or mentally searched for, for at least 1d4 rounds, to establish contact.

Sarphardin brains are used in spell inks for spells concerned with mental communications, and some whisper that the Arcane work with sarphardin to make helms (the two races have amicable relations, sarphardin often carrying Arcane through space).

Sarphardin skin, scaly and tough in life, shrivels to uselessness upon death. The flesh beneath, however, is said to be very nourishing (a 10 pound chunk can feed an active warrior for one month), decays very slowly, and is prized by alchemists and wizards.

When spelljamming, sarphardin have a personal Ship Rating of 4, and give a towed ship this SR (If two sarphardin combine to tow a ship of larger than 30 tons, it has an SR of 3 while under tow).

Skullsnake

Undead sarphardin have been encountered. Skeletal and evil, seeking to destroy all non-sarphardin life, these are believed to have been created by evil humans and magic-using beholders.

Skullsnakes retain the use of their spells and physical attacks, and their skeletal bites gain an additional 1d10 points of life-force-draining, chilling damage. Their morale rises to Fearless (19-20); they turn as “Special.” Their rate of regeneration slows to 1 hit point per turn. The XP Value of a Skullsnake is 7,000.

Shadowsponge ("Air Stealer")

SJR1



CLIMATE/TERRAIN:	Any space
FREQUENCY:	Rare
ORGANIZATION:	Solitary or groups
ACTIVITY CYCLE:	Any
DIET:	Special
INTELLIGENCE:	Semi- (2-4)
TREASURE:	Nil
ALIGNMENT:	Chaotic neutral

NO. APPEARING:	1-6
ARMOR CLASS:	9
MOVEMENT:	Fl 13 (C)
HIT DICE:	7+7
THACO:	13
NO. OF ATTACKS:	1
DAMAGE/ATTACK:	1-4/round (constriction) or 1 (ram)
SPECIAL ATTACKS:	Gas effects
SPECIAL DEFENSES:	Nil
MAGIC RESISTANCE:	Nil
SIZE:	G (ovoid, 36' + long)
MORALE:	Steady (11)
X.P. VALUE:	1400

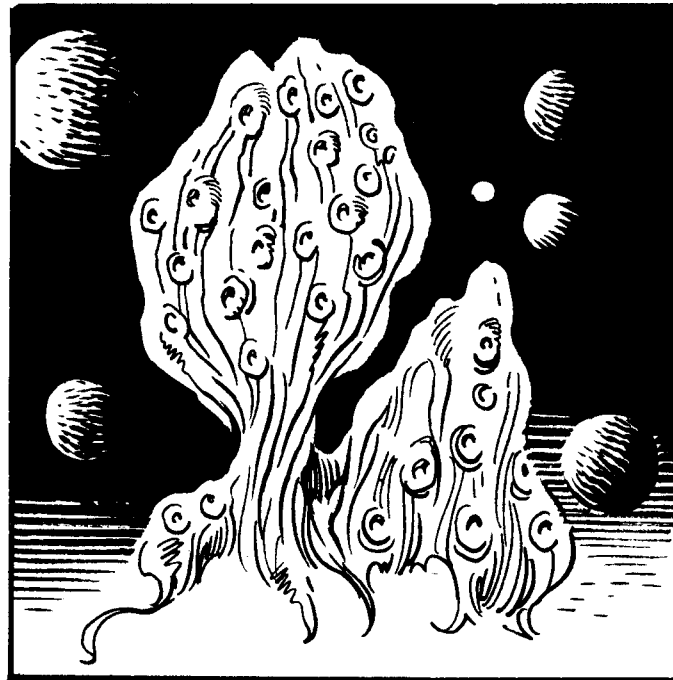

These strange monsters are feared by all spacefarers. They drift in space until they sense the approach of an atmosphere, and attack mindlessly, absorbing precious air.

A shadowsponge appears as a greyish sponge. Hundreds of rubbery, many-branched air sacs protrude from a central mass. Studded with small, keen eyes and sensory patches, a sponge can 'smell' air in the void up to three miles away.

The substance of a shadowsponge is inedible. If struck by fiery or electrical attacks (which do normal damage), it burns with a thick, choking smoke. The smoke expands rapidly to fill a 30' spherical area, and lasts for 2-5 turns, completely blocking normal vision beyond 4', and turning clean air within its confines to foul.

Combat: A shadowsponge concentrates on absorbing air, swooping and turning continuously in an atmosphere. Any nearby creature risks being rammed or enveloped.

A ram (successful attack roll required) does 1 point of damage. The victim must make a Strength Check or be bowled over (items carried must save vs. "fall").

An enveloping attack surrounds a victim, squeezing and smothering for 1 point of initial damage. In subsequent rounds, enveloped beings suffer 1-4 points of constriction damage. They may automatically hit the shadowsponge with any piercing or slashing weapons in hand, but are unable to cast spells, get out other items, or wield bludgeoning weapons. Very large sponges (those of over 40 hp) can envelop two M-sized beings at once; smaller shadowsponges can entrap only one.

Any attack on a sponge may be partially suffered by an enveloped being. The being saves against the attack form (for physical weapon attacks, against Breath Weapon) to avoid taking a quarter of the damage done to the sponge (round fractions down to a minimum damage of 1 hp).

The porous, air-filled nature of a shadowsponge prevents enveloped beings from suffocating, but they must save vs. Breath Weapon on every second round or suffer the effects of harmful gases absorbed earlier by the sponge (refer to Gas Clouds in the "Flotsam of Space" section for such effects).

When a sponge is killed or dealt over 20 hp damage in a

single round, it convulsively releases enveloped beings (who suffer damage from the attacks causing their release).

Habitat/Society: Shadowsponges are only semi-intelligent, but seem to herd together by instinct and move toward atmospheres in space. They avoid the large, stable atmospheres of worlds. Some sages believe shadowsponges are merely a stage in the lives of more advanced fungoid creatures. This stage, it is thought, ends when a sponge reaches a certain inner state by absorbing the nutrients it needs from absorbed gases. It then enters a world's atmosphere and falls to the surface, metamorphosing into spores to begin life anew in some other form.

Elminster cautions us that although this theory cannot be discounted, definite proof in support of it is so far lacking for several parts of the hypothetical life-cycle; the true nature of shadowsponges may be far different.

Shadowsponges never collide with each other or fight among themselves. They seem capable of rejoining scattered portions of themselves, or even joining with another sponge to form a larger whole, and have no reproductive lives or family units.

Ecology: Shadowsponges feed on nutrients gleaned from gases, absorbed light, and low level electrical and heat energy. Attacks relying entirely on heat for damage, and not flame (which has its usual effect), do not harm a shadowsponge, but rather give it additional or healing hit points equal to the normal damage done.

Sponges play no part in any food-chain. Alchemists and spell researchers of all races have looked in vain for uses for shadowsponge tissue and essence.

One experiment has given questionable results. Application of low-level electrical energy generated by a *shocking grasp* spell and certain gnomish energy creation and storage devices causes the sponge to release 25% of its stored atmosphere.

Desperate spacefarers have been known to enclose shadowsponges in a spacewreck or other large, sturdy spacegoing storage container and forcibly drag them through

Shadowsponge (“Air Stealer”)



planetoid atmospheres, and to skim the atmospheres of worlds. The intent of this stratagem is to gain a portable atmosphere allowing a too-small ship to carry too-large a crew on too-long a space voyage. A secondary use of caged shadowsponges is to steal air from enemies by setting a spacegoing cage adrift on a course that will bring it through the atmosphere of, or into a collision with, a hostile planetoid, base, ship, or elven armada craft.

Shadowsponges imprisoned or brought into contact with planetary atmospheres will take on and store air usable in space voyages, but the shock of this treatment seems to ultimately kill them. Each sponge saves vs. Petrification for every day of confinement. If it fails, it dies instantly, poisoning the air around it.

A dying shadowsponge fouls 40 tons of air. Once the entire carried atmosphere of a ship is fouled, additional 40-ton foulings turn 40 tons of fouled air into deadly air. Many an intrepid space explorer has been forced to cut loose towed space barges full of dead shadowsponges to escape the poisoned air and stagger along on inadequate air reserves.

Herd Clouds

Some small, dark shadowsponges have been observed to lead their fellows on long voyages in space and round them up into groups. These “herd clouds” have recently been studied with interest by several sages.

Herd clouds have been found to be Very intelligent (11-12) and possessed of unusually high morale: Champion (15-16). They have 8 +8 Hit Dice and an XP Value of 3000.

They also have the ability to gather electrical charges, discharging these as weapons against other beings. A typical herd cloud can emit one 9d6 *chain lightning* attack and two forked 6d6 *lightning bolts* in a “day” (144-turn period). Mere contact with, or even passing through a ‘charged’ herd cloud will not attract such damage unless the cloud wishes to release its energy.

Some sages and alchemists believe that herd cloud essence can be harnessed in some way to guard against or generate electrical magical attacks, but experiments in this line have so far been shocking disasters.

CLIMATE/TERRAIN:	Any space
FREQUENCY:	Common
ORGANIZATION:	Pack
ACTIVITY CYCLE:	Any
DIET:	Omnivore (anything organic)
INTELLIGENCE:	Low (5-7)
TREASURE:	J,K,L,N,Q,V (two types each)
ALIGNMENT:	Chaotic neutral

NO. APPEARING:	4-48 (4d12)
ARMOR CLASS:	7
MOVEMENT:	3, Fl 17 (A)
HIT DICE:	1-1
THACO:	15 (20)
NO. OF ATTACKS:	1
DAMAGE/ATTACK:	2-5 (young: 1-2)
SPECIAL ATTACKS:	Continuous damage unless dislodged, attack eyes
SPECIAL DEFENSES:	Immune to poisons and diseases
MAGIC RESISTANCE:	Nil
SIZE:	S (average 3' long); young are T (average 1' in length)
MORALE:	Average (10)
X.P. VALUE:	65

These miniscule but feared menaces of space attack spacefaring ships and beings alike, eating furrows in the surfaces of all organic things they encounter. They are particularly fond of eating eyes. Entire crews blinded by spaceworms have been found wandering despairingly in space, with no idea of where they are or are heading.

Spaceworms resemble pallid-white, glistening sea slugs of up to three feet in length. They swarm over ships, chewing up wooden or bone hulls and attacking deck crew. If particularly hungry, they penetrate to eat food in the hold, sleeping crew members, etc.

Combat: Spaceworms attack in packs, darting this way and that to overwhelm foes. They are unpredictable: when encountered, roll 1d8 (one die per four worms, for large groups):

On a result of 1, the spaceworms split apart in a welter of glistening slime and rent skin, revealing 1-3 tiny worms. These do only half damage, and wander aimlessly for 1 round after birth. Their reactions should then be checked on a d8.

On a 2, the worms cruise past, ignoring all potential meals.

On a roll of 3 or 4, the spaceworms will not attack, but one or more will come to rest on the ship or other solid object, darken, and die. Amid the melting pool of wrinkled skin and spreading slime, treasure is 80% likely to be found (see Ecology, below).

On a result of 5 to 8, the spaceworms attack relentlessly, striking (as 5-hit die monsters, not as their hit points would ordinarily indicate) until slain or sated. A spaceworm is sated when it has caused 12 hit points of damage. It will break off combat and cruise into space, dodging to avoid attacks.

Unlike the rot grub known on many worlds, a spaceworm does not burrow below the skin when attacking. Instead it eats furrows in flesh, wood, and plant matter alike, gouging along the surface with razor-sharp teeth. These furrows continue from round to round (causing automatic damage) unless the worm is wounded, in which case it will tear free and swoop in to attack again.



Habitat/Society: Spaceworms come from the seas of certain worlds. New varieties (some rumored to have strange powers) adapt to space continually. Spaceworms eat and cruise, eat and cruise until attaining a certain size, whereupon they split—in mid-air, and at any time—to produce 1-3 young. These grow to full size and strength in 10-40 days.

Spaceworms tend to hunt with others of their species, but may also be encountered alone. They have no stable family units, yet some elven sages believe that spaceworms are slowly advancing in intelligence and social development with successive generations.

Ecology: Spaceworms do not need to breathe and are not harmed by differences in atmosphere or by extreme cold (flames, electricity, and excessive heat do normal damage). Alchemists working with spaceworm slime and distilled essence have so far met with limited success in finding any worthwhile uses.

Old spacehands know that if a spaceworm is slit open or squashed, and its thick, viscous, and colorless or slightly mauve slime is applied to an open wound within seven rounds of the wound's creation, the slime will neutralize all known diseases and poisons and stop further bleeding and infection by sealing wounds, but does not heal physical damage (spaceworms are themselves immune to all known diseases and poisons).

Spaceworms may have small pieces of valuable swallowed treasure (such as coins, gems, and magical rings) trapped inside their bodies. Spaceworm bodies are flexible and can expand to accommodate such foreign material—but only a well-stuffed spaceworm can be distinguished by girth from its fellows. A spaceworm which splits to create young releases all treasure held in its body into its surroundings; young spaceworms do not inherit the treasure of their parent into their own bodies.

Some spacefarers have been known to eat spaceworms. This somewhat less than savory topic is discussed under Spaceworms in the "Flotsam of Space" section.

Tinkerer ("Giant Bubble")

SJR1



CLIMATE/TERRAIN:	Any space
FREQUENCY:	Very rare
ORGANIZATION:	Wandering; solitary or bands
ACTIVITY CYCLE:	Any
DIET:	Omnivore
INTELLIGENCE:	Highly (13-14)
TREASURE:	V (sometimes x3 or 4)
ALIGNMENT:	Chaotic neutral

NO. APPEARING:	1-8
ARMOR CLASS:	6
MOVEMENT:	16 (bounce; also up to 20' vertically), Fl 14 (A)
HIT DICE:	4+4
THACO:	17
NO. OF ATTACKS:	7
DAMAGE/ATTACK:	2-5 and 1-2 (or by weapon type) x6
SPECIAL ATTACKS:	Use magical items
SPECIAL DEFENSES:	Regeneration
MAGIC RESISTANCE:	Nil
SIZE:	S (3'-4' diameter)
MORALE:	Very Steady (13-14)
X.P. VALUE:	650

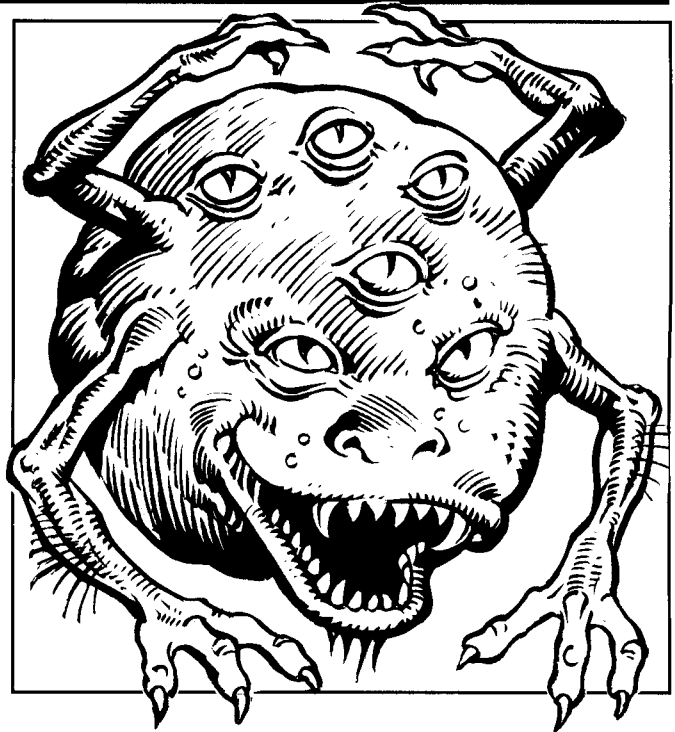

Tinkerers are ball-shaped, comical-looking creatures named for the aims they all seem to follow: to acquire, improve upon, and modify all equipment (including magical items) they can get their hands on. This includes, of course, everything humans carry and use! They covet tools and magical items highly, and have been known to swallow small, non-sharp items to examine later.

Tinkerers will also experiment with living organisms, including humans, to modify their body-forms or mate them with machinery (endowing humans with weapon-equipped limbs, for example).

Most experiments harm or disable the subjects (who must either be willing or unable to resist), but both reavers and wonderseekers have been encountered with limbs replaced by intricate weapons or tools (saws, scythes, and plier-like gripping claws). Some beings even have sockets that will take a variety of tools and weapons. Such beings are very rare—and, like tinkerers themselves, extremely rare in the well-travelled areas of space.

Tinkerers are spherical, floating creatures with six eyes set around their bodies, four arms with ball-joints at wrists and elbows; and hands consisting of three opposed digits. They can thus see and reach in all directions at once.

Combat: Tinkerers can bite anything that they can bounce on top of, or sit on, for 2-5 points of damage (their mouths are large enough to take in a human head), but their puny fists can hit for only 1-2 points of damage each.

Few warriors laugh at a tinkerer twice, because the comical, bouncing little creatures can wield weapons in all six arms for normal damage.

A piercing attack that deals a tinkerer more than 10 points of damage in a single round causes it to explode violently. This terminates the unfortunate tinkerer's corporeal existence, and deals every being within ten feet 3-12 points of blast damage (no saving throw). Items swallowed or held by the tinkerer may have to make saving throws vs. Crushing Blow if flung into things. They may also become missiles, menacing creatures nearby (2-5 or 2-8 damage depending on size, attack rolls to hit endangered beings).

Habitat/Society: Tinkerers seem to be a race of lost, scattered wanderers, who roam space looking for something.

Khelben Arunsun and Elminster believe them to be one of the oldest spacefaring races, who either abandoned organized spacefaring society and the ships that must support it, or who lost much of their civilization and knowledge in some sort of cataclysm, and are slowly and painfully striving to improve themselves over the passing generations to regain it.

Tinkerers travel constantly, hitching rides with all manner of ships and spacefaring races that use them. They are attracted to gnomes, dwarves, sarphardin, and humans, and can often be found drifting around the space vessels of those races, generally getting in the way and monkeying with everything. They can and do use most human weaponry, tools, conveyances, and other equipment.

Ecology: Tinkerers are covered with spherical, translucent grey pock-marks, pores through which they "breathe" in gases from their surroundings. Membranes filter out edible pollens, mold spores, germs, and other protein from airborne dust particles. Thus tinkerers can go for long periods without food as we know it, and are immune to all known human poisons and diseases. They can clean air for ships on long voyages (each tinkerer keeping one ton of air pure) and are sometimes captured and towed for this reason.

Tinkerers float about, travelling by means of a controlled release of the gas they take in, in tiny jets. Thus, they can spin, perform aerobatics, and so on with great precision. To remain stationary, a tinkerer expels even amounts of gas all around, taking gas in as needed (and pulsing all over).

They have large mouths on their undersides, and eat the same things humans do, being addicted to sugared candy and sweets.

Tinkerers also regenerate at a rate of 1 hit point every 3 rounds, requiring contact with water to do so. They often carry canteens with them for this purpose.

Advanced Dungeons & Dragons
2nd Edition



Lost Ships

by Ed Greenwood

Who among you who have dared to enter the starry deeps has not heard of the dark, drifting derelicts of earlier spacefarers? The silent, menacing lairs of monsters that may hide great treasures for those bold enough to explore them? And what space-captain plies the spacelanes who does not dream of a bigger, sleeker, more powerful ship than his present one?

Lost Ships holds the answers that bold spacefarers have been seeking:

- **Monsters!**
- **New spells** to better arm intrepid adventurers.
- **New Ships!** Twenty new ship types.
- **Flotsam of Space**—mini-menaces that can bring space to exciting life.
- **New rules** to help DMs run extended space adventures.
- **New adventures** galore that can make any spacebound AD&D® game campaign an exciting (and dangerous!) place for your characters!

Lost Ships is your first-class ticket to high adventure in space!

TSR, Inc.
POB 756
Lake Geneva
WI 53147
U.S.A.



TSR Ltd.
120 Church End
Cherry Hinton
Cambridge CB1 3LB
United Kingdom

ISBN 0-88038-831-5



9280XXX1401

\$9.95 U.S.

ADVANCED DUNGEONS & DRAGONS, AD&D, SPELLJAMMER, and the TSR logo are trademarks owned by TSR, Inc.
© 1990 TSR, Inc. All rights reserved. Printed in U.S.A.